

# Watch Operation Guide 3516

**CASIO®**

## Applicable Products

- DW-H5600

## Contents

### Easy Operation

Performing Activity Measurement with the Watch

Using the Phone App to View Activity Results

Recover Support and Health Management

### Before Using the Watch

Watch Features

Charging

- Charging the Watch
- Solar Assist Charging
- Checking the Charge Level
- Charging Time Guidelines
- Power Saving

Connecting with a Phone

- Pairing the Watch with Your Phone
- Connecting with a Phone Paired With the Watch
- Unpairing
- After Purchasing Another Phone

Creating Your Profile

Mode Overview

- Watch Mode
- Activity Mode
- Control Mode

### Performing Activity Measurement

Activity Overview

Performing Activity Measurement

Using the Timer for Interval Training

- Overview
- Timing with Interval Timers
- Pausing and Resetting the Timer

Starting Heart-rate Training

Activity Measurement Precautions

### Viewing Activity Log Records

Viewable Activity Log Items

Viewing Activity Records

Deleting Activity Records

- Deleting Specific Data
- Deleting All Activity Data

### Viewing Your Training Performance Condition

Viewing Your Cardio Load Status

### Using Nightly Recharge™ to Check Your Recovery Status

Checking Nightly Recharge™ Status

### Breathing Exercises

Setting a Breathing Exercise Duration

Measuring a Breathing Exercise

### Smart Alarm

Configuring Smart Alarm Settings

Turning Off Smart Alarm

### Measuring Your Heart Rate

Checking Your Current Heart Rate

Using Heart Rate Measurement

Heart Rate Measurement Precautions

### Blood Oxygen Level Measurement

Measuring Your Blood Oxygen Level

### Pedometer

Counting Steps

Causes of Incorrect Step Count

### Viewing Life Log Data

Viewing Life Log Data

### Almanac (Sunrise and Sunset Times, and Moon Age)

Checking Sunrise and Sunset Times, and Moon Age

### Time Adjustment

Automatically Connecting with a Phone to Sync the Current Watch's Time Setting

- Auto Time Adjustment
- Manually Connecting with a Phone to Sync the Watch's Time Setting

Using Watch Operations to Adjust the Time Setting

### World Time

Configuring World Time Settings

### Alarm

Configuring Alarm Settings

Enabling the Hourly Time Signal

Turning Off an Alarm

## Stopwatch

- Measuring Elapsed Time
- Measuring a Split Time

## Timer

- Setting a Start Time
- Using the Timer

## Receiving Phone Notifications

- Enabling and Disabling Incoming Call Notifications
- Displaying Notification Contents
- Cycling Between Notification Cut-in Displays
- Deleting a Notification
  - Deleting a Particular Notification
  - Deleting All Notifications

## Activity Measurement Settings

- Enabling Auto Lap Timing
- Enabling Auto Pause
- Configuring Training Alert Settings
- Training Alert Screen Indicators
- Alert Screen Switching
- Configuring Interval Timer Settings

## Using the Application to Configure Settings

- Specifying a Watch Face
- Customizing the Watch Mode and Activity Mode Functions
- Configuring Activity Measurement Display Settings
- Using Your Phone's GPS
- Enabling the Wrist Sensor
- Specifying Your Desired Bedtime and Wake-Up Time
- Specifying a Daily Step Count Target
- Configuring Watch Settings

## Other Settings

- Changing the Watch Face
- Turning On Silent Mode
- Enabling Step Reminder
- Specifying the Night Time
- Configuring Sound and Vibration Settings
  - Configuring Operation Sound and Vibration Settings
  - Configuring Notification Sound and Vibration Settings
- Configuring the Auto Light Setting
- Specifying the Illumination Duration
- Enabling Power Saving
  - Disabling Power Saving
- Changing the Length and Weight Units
- Specifying the Calorie Display Unit

## Basic Information

- General Guide
- Indicators
- Viewing the Face in the Dark
- Fastening the Watch to Your Wrist
- Updating the Watch's Software Version
- Resetting Watch Settings
- Phone Finder
- Entering the Watch Airplane Mode

## Specifications

## Other Information

- City Table
- Summer Time Table
- Fitness Categories
- Supported Phones
- Message Screen List
- Checking Wireless Compliance Information
- Copyrights and Registered Copyrights
- Software

## Troubleshooting

## Precautions

- Operating Precautions
- User Maintenance
- Battery
- Mobile Link Precautions

## Easy Operation

### Performing Activity Measurement with the Watch

You can use the watch to view activity data measured while wearing the watch. The flow of this operation is shown below.

#### ● Measurement Flow (Running Measurement)

1. Affix the watch correctly to your wrist.  
[🔗 Fastening the Watch to Your Wrist](#)
2. Perform the required watch operations to select [RUNNING] from among the activity measurement options.  
[🔗 Performing Activity Measurement](#)
3. Start running.  
 Perform the required watch operation to start measurement.  
[🔗 Performing Activity Measurement](#)
4. Finish running.  
[🔗 To end activity measurement](#)
5. Save the measured data.  
[🔗 To end activity measurement](#)
6. Use the watch to view the measured data.  
[🔗 Viewing Activity Log Records](#)

#### Note

- When measuring an activity other than running, select an option other than [RUNNING] in step 2, above.

#### ● Useful Functions

You can customize the activity measurement settings below to allow more effective measurement.

- Auto lap measurement, Auto lap distance
- Auto pause
- Heart Rate Zone

Besides these, other settings can be customized. For details, see the information below.

- [🔗 Performing Activity Measurement](#)
- [🔗 Activity Measurement Settings](#)
- [🔗 Starting Heart-rate Training](#)

### Using the Phone App to View Activity Results

You can use the “CASIO WATCHES” phone app to view activity data you measured with the watch.

The flow of this operation is shown below.

#### ● Getting Ready

Before measuring activity data for the first time, you need to prepare by performing the following steps. You do not need to perform these steps again for subsequent activity measurements.

- Connecting with a Phone
    - Install the “CASIO WATCHES” phone app on your phone
    - Pair the watch with your phone
- [🔗 Pairing the Watch with Your Phone](#)

#### ● Measurement Flow (Running Measurement)

1. Affix the watch correctly to your wrist.  
[🔗 Fastening the Watch to Your Wrist](#)
2. Perform the required watch operations to select [RUNNING] from among the activity measurement options.  
[🔗 Performing Activity Measurement](#)
3. Start running.  
 Perform the required watch operation to start measurement.  
[🔗 Performing Activity Measurement](#)
4. Finish running.  
[🔗 To end activity measurement](#)
5. Save the measured data.  
[🔗 To end activity measurement](#)
6. Check the measured data with the watch or the CASIO WATCHES phone app.  
[🔗 Viewing Activity Log Records](#)

#### Note

- When measuring an activity other than running, select an option other than [RUNNING] in step 2, above.
- Measured data is transferred from the watch to CASIO WATCHES phone app at the timing noted below.
  - Immediately after a measurement operation, while connected to the phone, is complete
  - If you are not connected to your phone during measurement, immediately after reconnecting
  - If your phone is turned off, immediately after it is turned on, and CASIO WATCHES phone app is started up
- If you cannot connect to your phone or transfer data, restart CASIO WATCHES phone app.

#### ● Useful Functions

You can customize the activity measurement settings below to allow more effective measurement.

- Activity Measurement Screen
- Auto lap measurement, Auto lap distance
- Auto pause
- Training Alert
- Heart Rate Zone

By linking with the CASIO WATCHES phone app, you can display the running distance and pace using the location information from your phone.

Besides these, other settings can be customized. For details, see the information below.

- [🔗 Performing Activity Measurement](#)
- [🔗 Activity Measurement Settings](#)
- [🔗 Starting Heart-rate Training](#)
- [🔗 Using Your Phone's GPS](#)

## Recover Support and Health Management

This section explains the operation flow for operations for functions that support the body.

### ● Blood Oxygen Level Measurement

This function measures your blood oxygen level. You can view measurement results on your watch.

### ● Sleep Measurement (Nightly Recharge™)

If you wear your watch in bed, you can keep track of your physical condition while you are sleeping and the quality of your sleep. You can view measurement results on your watch and with the phone app.

### ● Breathing Exercise (Breathing Exercise)

This mode supports stress reduction using guidance that promotes breathing at a slow and stable rhythm. You can view measurement results on your watch.

### ● Step Reminder

When the watch detects that your step count over a certain period is low, it notifies you and encourages you to walk more. If the watch performs this Step Reminder notification operation, try walking for about five minutes.

### ● Blood Oxygen Level Measurement

1. Affix the watch correctly to your wrist.  
[🔗 Fastening the Watch to Your Wrist](#)
2. Start blood oxygen level measurement.  
 After the measurement operation is complete, the watch displays the measurement result.  
[🔗 Measuring Your Blood Oxygen Level](#)
3. View the measurement results on your watch.

#### Note

- For details about blood oxygen level measurements, see the information below.  
[🔗 Blood Oxygen Level Measurement](#)

### ● Sleep Measurement (Nightly Recharge™)

\* Powered by Polar

1. Specify your night time.  
[🔗 Specifying the Night Time](#)
2. Specify your bedtime and wake-up time.  
[🔗 Specifying Your Desired Bedtime and Wake-Up Time](#)
3. Select [ON] or [ACTIVITY & NIGHT TIME ON] for the heart rate measurement setting.  
[🔗 To enable or disable heart rate measurement](#)
4. Affix the watch correctly to your wrist.  
[🔗 Fastening the Watch to Your Wrist](#)
5. Get your normal sleep.  
 Measurement will automatically end when the watch detects that you have woken up.
6. View the measurement results on your watch.  
[🔗 Checking Nightly Recharge™ Status](#)

#### Note

- You cannot use watch operations to configure bedtime and wake-up time settings. To configure bedtime and wake-up time settings, pair the watch with your phone and then use CASIO WATCHES phone app to configure settings.  
[🔗 Pairing the Watch with Your Phone](#)
- For information on sleep measurement, see the information below.  
[🔗 Using Nightly Recharge™ to Check Your Recovery Status](#)
- You can view sleep measurement results on your watch. Note that you cannot view sleep analysis results on your watch. Use the CASIO WATCHES phone app to view sleep analysis results.
- To improve sleep analysis accuracy, it may take about one to two hours after you wake up for measurement results to be displayed on the watch.
- For details about sleep support functions, see the information below.  
[🔗 Smart Alarm](#)

### ● Breathing Exercise (Breathing Exercise)

\* Powered by Polar

1. Affix the watch correctly to your wrist.  
[🔗 Fastening the Watch to Your Wrist](#)
2. Start the breathing exercise.  
 Take deep breaths following the animation on the watch screen.  
 The watch displays the status of your mind and body in real time.  
 When you finish your breathing exercise, the watch displays measurement results.  
[🔗 Measuring a Breathing Exercise](#)
3. View the measurement results on your watch.

#### Note

- For information about breathing exercises, see the information below.  
[🔗 Breathing Exercises](#)  
[🔗 Setting a Breathing Exercise Duration](#)

### ● Step Reminder

1. Enable Step Reminder.  
[🔗 Enabling Step Reminder](#)
2. The watch notifies you when it detects that your step count over a certain period is low.  
 Press any button to clear the notification.

#### Note

- If behavior analysis does not detect walking and running, the watch may notify you that step reminder has determined that your step count is low.

## Before Using the Watch

### Watch Features

#### • Phone Linking

You can transfer activity data to a Bluetooth® capable phone and work with it using phone applications.

#### • Activity Function

Use this function to measure and record distance, elapsed time, pace, and other activity data.

#### • Activity Log

Activity Log can store up to 100 records of data acquired during activity measurement.

#### • Life Log

You can use Life Log to check your step count, calories burned, active time results, and other information.

#### • Heart Rate Measurement

This function measures your estimated heart rate.

#### • Blood Oxygen Level Measurement

This function measures your blood oxygen level.

#### • Breathing Exercise

This function guides you through breathing exercises.

#### • Nightly Recharge™

This function analyzes your sleep and provides information about your physical recovery.

### Important!

- This watch is not a special-purpose measuring instrument. Measurement function readings are intended for general reference only.
- Accuracy is not guaranteed for the numerical measurement data calculated by the sensors. Numerical measurement data should be regarded as reference values.

### Note

- The illustrations included in this operation guide have been created to facilitate explanation. An illustration may differ somewhat from the item it represents.
- You can obtain more accurate display values by creating a profile before measuring your heart rate or activity data.  
[🔗 Creating Your Profile](#)
- Depending on the version of your watch's software, its operations and display contents may differ from those described in this Operation Guide.
- You may need to upgrade your watch software to use the functions and to display the screens described in this Operation Guide. Use of the latest software version is recommended.  
[🔗 Updating the Watch's Software Version](#)

### Charging

Use the provided charging cable to charge the watch.

The current time display is powered by solar charging even when the battery charge is low.

### Charging the Watch

#### Important!

- Use only the supplied charger cable for charging.
- A device with a USB port (Type-A) can also be used for charging.
- Note that no guarantees are made concerning the suitability of all types of USB ports for charging. If charging is not possible for some reason, disconnection from the USB port is recommended.
- Place the charger on a desk or other stable surface, making sure there is plenty of open space around it. Charging with the charger and watch in a bag or some other enclosed space can cause overheating of the watch.
- Should water or any other liquid get onto the watch or charger cable during charging, immediately unplug the charger cable from the power source.
- Perform charging in an environment where ambient temperature is between 5 °C and 35 °C (41 °F and 95 °F).
- Avoid pinching your hands or fingers in the gap of the clip of the charging cable.

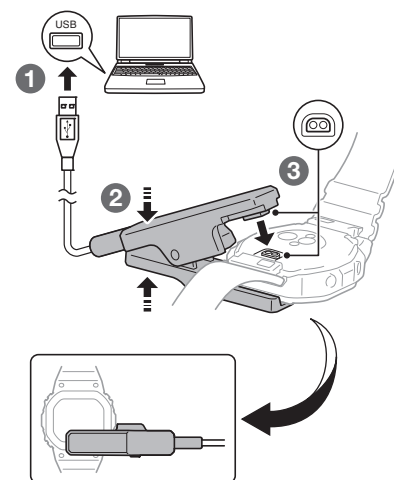

1. Turn on your computer or other device with a USB port (power source), and connect the charger cable to it.
2. Open the charging cable clip.

3. Align the electrodes of the clip with the charging terminals of the watch, and fasten the clip to the watch.

- flashes when charging starts.



- When a full charge is reached, appears on the display, and disappears. Charging stops at this time.



### ● Charging from a Non-computer Device's USB Port

You can charge using power from a USB port (Type-A) that meets USB standards.

- Voltage: 5 V
- Current: 0.5 A min.

### ● Precautions When Charging

- A charging operation will not start while the battery level indicator shows . To prolong the life of the watch's rechargeable battery, charge only when the battery level indicator shows or lower.
- Do not attempt charging at high ambient temperatures of 35 °C (95 °F) or greater. The watch becomes hot during charging, which can cause charging to stop automatically. High ambient temperature may result in a less than full charge.
- Operation on a custom computer or a computer that has been modified from its original configuration is not guaranteed.
- The watch may become warm during charging. This is normal and does not indicate malfunction.

#### Note

- Starting from a blank display, it takes about 3.2 hours to achieve a full charge.
- Charging time depends on ambient temperature and other factors.

### | Solar Assist Charging

Even if the watch battery level indicator reaches , the current time display, stopwatch, timer, world time, and alarm are powered by solar charging, which charges the rechargeable battery using power generated by the solar panel.

The solar panel is integrated into the LCD of the watch, and power for charging is generated whenever the face is exposed to light.



While you are wearing the watch, make sure that its LCD (solar panel) is not blocked from light by the sleeve of your clothing. Power generation efficiency is reduced even when the LCD is blocked only partially.

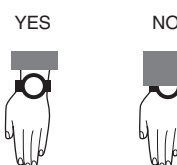

#### Important!

- Solar assist charging is an auxiliary function that maintains display of the current time even when the battery charge is low. Connect the charging cable and charge the watch as soon as possible after the battery indicator shows .
- Certain environments can cause the watch to become extremely hot, which creates the risk of burn injury and damage to internal watch components. Avoid placing the watch for extended periods in locations like the ones described below, where temperatures are likely to rise above 60°C (140°F).
  - On the dashboard of a vehicle parked in the sun
  - Near incandescent lamps, camera lights, halogen lamps, or other sources of heat
  - In locations exposed to direct sunlight for long periods and other hot locations

## Checking the Charge Level

You can determine the watch's current charge level by checking the battery indicator.

Level	Indicator	Usable Functions
HIGH		All
4		
3		
2		
1		
LOW		Current time screen, stopwatch, timer, World Time, alarm
CHG	<ul style="list-style-type: none"> <li>No segments displayed.</li> <li>[CHARGING BATTERY] (Charging) is displayed while charging with USB.</li> </ul>	

- The display goes blank when the battery goes dead.

## Important!

- Available watch functions are limited when the battery indicator shows . Connect the charging cable and charge the watch as soon as possible after the battery indicator shows .
- Leaving the watch without charging for several months results in over-discharge and may make future charging impossible. If this happens, contact your original retailer.
- Only the following functions are available while the battery indicator shows : current time display, stopwatch, timer, World Time, alarms.
- Even when the battery indicator shows , the current time can be maintained by solar charging.
- If the battery is dead and the watch display is blank, use the charger cable to charge the watch.
- Regular charging at least once a month is recommended to extend battery life, even if you do not use the watch during that time.

## Note

- Solar charging cannot charge the battery up to the level.

## Charging Time Guidelines

Charging the watch daily for the approximate times shown below should maintain a charge of or higher.

[Checking the Charge Level](#)

## Note

- Actual charging time depends on the charging environment, watch settings, and other factors.

## Charging with the Charging Cable

### Charge Recovery Times

Blank display → HIGH (Full charge)	Approx. 3.2 hours *
CHG → LOW	Approx. 12 minutes
LOW → Level 1	Approx. 20 minutes
Level 1 → HIGH (Full charge)	Approx. 2.9 hours

\* Approx. 6 hours when ambient temperature is 5°C to 10°C (41°F to 50°F)

## ● Solar Charging

Time required to maintain the current time display by solar charging even when the battery level is “LOW”

Light Level (Lux)	Approximate Charging Time
50,000 lux (Sunny day outdoors, etc.)	9 minutes
10,000 lux (Sunny day near a window, etc.)	42 minutes
5,000 lux (Overcast day near a window, etc.)	83 minutes
500 lux (Indoor fluorescent lighting, etc.)	14 hours

### Note

- Charging is performed even with exposure to indoor fluorescent lighting (500 lux). The watch will be able to maintain a charge of **LOW** or higher if it is exposed to indoor fluorescent lighting for eight hours a day, in addition to light near a window on a sunny day (10,000 lux) for two hours a week.

## Power Saving

If there is no movement for a certain period, the watch will disconnect from your phone and enter sleep mode.

- You can put the watch into a power saving mode manually.

[Enabling Power Saving](#)

### Display Sleep

Leaving the watch in the dark for about an hour between 10 pm and 5:50 am causes the screen to go blank.

### Function Sleep

If the watch is left in display sleep for seven days, sensor measurement and other functions will become disabled.

## ● To exit power saving (sleep state)

Press any button or perform any watch operation to exit power saving (sleep state).

## Connecting with a Phone

To use your watch in combination with a phone, you first need to pair them. You can get the most out of the functions of this watch by using it in combination with your phone.

### Pairing the Watch with Your Phone

To use your watch in combination with a phone, you first need to pair them. Perform the steps below to pair the watch with a phone.

#### ● ① Install the required app on your phone.

In Google Play or the App Store, search for the “CASIO WATCHES” phone app and install it on your phone.

### Important!

- To pair the watch, you must first install the “CASIO WATCHES” app and log in with a CASIO ID. If you already have a CASIO ID, use it to log in. If you do not have a CASIO ID, follow the on-screen instructions to register a new one and then use it to log in.

#### ● ② Turn on location services

Turn on your phone’s location services.

### Note

- For details about setting procedures, see your phone documentation.

#### ● ③ Configure Bluetooth settings

Enable the phone’s Bluetooth.

### Note

- For details about setting procedures, see your phone documentation.

#### ● ④ Pair the watch with your phone

Perform the operation below to pair the watch with your phone for the first time.

- Move the phone to be paired with close to (within one meter of) the watch.
- Tap the “CASIO WATCHES” icon.
- Tap the **+** of the “My Watch” tab.
- Perform the operation shown on the phone screen to register the watch to the CASIO WATCHES phone app.
- Display the current time.  
[Watch Mode](#)
- Hold down (C) for at least two seconds. This displays the [SETTING] screen.



- Press (A). This displays the setting menu screen.

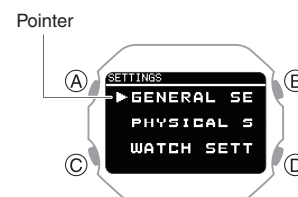

- Use (C) to move the pointer to [GENERAL SETTINGS].
- Press (A).
- Use (C) to move the pointer to [PAIRING].
- Press (A).
- Use (C) to move the pointer to [PAIRING].
- Press (A).

14. When the watch you want to pair with appears, follow the instructions on the display to pair with it.

- If a pairing prompt message appears, perform the operation shown on the phone screen.
- If pairing fails, the watch returns to the state in step 10 of this procedure. Perform the pairing procedure again from the beginning.

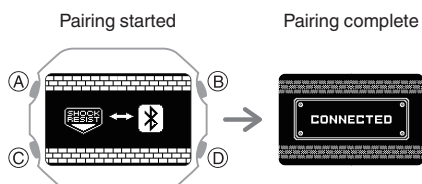

- After pairing is complete, use the CASIO WATCHES phone app to register the watch's initial settings and profile settings. Profile settings can also be configured on the watch.

[Creating Your Profile](#)

## Note

- The first time you start up the CASIO WATCHES phone app, a message will appear on your phone asking if you want to enable location information acquisition. Configure settings to allow background use of location information.
- For information about what to do when pairing is unsuccessful, see the information below.

[I can't pair the watch with a phone.](#)

- If your watch is already paired with another phone, you won't be able to select [PAIRING] on the screen in step 12. Unpair your watch from the other phone before pairing it with your phone.

[Unpairing](#)

- If this watch is already registered with the CASIO WATCHES phone app, select it from the registered watches displayed on the "My Watch" tab in step 3 of this procedure and pair it.

## Connecting with a Phone Paired With the Watch

Your watch automatically connects with its paired phone.

The symbol is displayed at the bottom of the watch screen while the watch is connected with a phone. flashes when there is no connection between the watch and a phone.

- If the watch is not paired with the phone you want to connect with, refer to the information below and pair them.

[④ Pair the watch with your phone](#)

## Important!

- If you have problems establishing a connection, it could mean that CASIO WATCHES phone app is not running on your phone. On your phone's home screen, tap the "CASIO WATCHES" icon. Perform the operation shown on the screen to pair with the watch.

If you cannot connect to the paired phone and data such as activities are not transferred to the phone, perform the procedure below to reconnect.

1. Display the current time screen.  
 [Watch Mode](#)
2. Hold down (C) for at least two seconds.  
This enters the Control Mode.
3. Use (C) to select [CONNECT].



4. Press (A).

This establishes a Bluetooth connection.

- When the connection is established, [CONNECTED] appears and is then replaced by [CONNECT] after a few seconds.

The data is transferred to your phone.

- If the connection fails, [FAILED] appears on the display.

## Note

- The watch stores up to three days of log data.  
Connect the watch and smartphone once every three days to transfer the data to the CASIO WATCHES phone app.

## Unpairing

Unpairing the watch from a phone requires both the CASIO WATCHES phone app and watch operations.

## Note

- If there is any pairing information remaining on your phone, delete that information as well.
- The watch cannot be unpaired from a phone while the watch's Airplane Mode is enabled. To unpair from your phone, disable the watch's Airplane Mode.

[Entering the Watch Airplane Mode](#)

## Deleting Pairing Information from the CASIO WATCHES phone app

1. Tap the "CASIO WATCHES" icon.
2. Tap the "My Watch" tab.
3. Tap the watch you want to unpair.
4. Tap the "•••".
5. Perform the operation shown on the phone screen to unpair.

## Note

- Deleting pairing information from the CASIO WATCHES phone app does not delete data previously transferred from your watch to the app.

## ● Deleting Pairing Information from the Watch

1. Display the current time.  
[Watch Mode](#)
2. Hold down (C) for at least two seconds.  
This enters the Control Mode.
3. Use (C) to select [SETTING].



4. Press (A).  
This displays the setting menu screen.

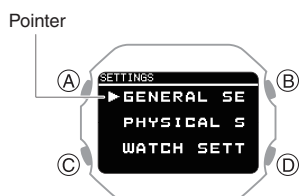

5. Use (C) to move the pointer to [GENERAL SETTINGS].
6. Press (A).
7. Use (C) to move the pointer to [PAIRING].
8. Press (A).
9. Use (C) to move the pointer to [UNPAIRING].

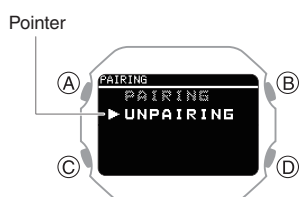

10. Press (A).
11. Use (C) to select whether or not you want to delete the pairing information.

[YES]	Deletes pairing information.
[NO]	Does not delete pairing information.

12. Press (A).

After deletion of the pairing information is complete, [UNPAIRED] appears for a few seconds, and then the display returns to the screen in step 9 of this procedure.

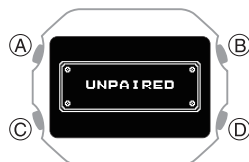

13. Display the current time.  
[Watch Mode](#)

## ● Deleting the phone's pairing information

For details about setting procedures, see your phone documentation.

"Settings" → "Bluetooth" → Cancel the watch's device registration.

## After Purchasing Another Phone

You need to perform the pairing operation whenever you want to establish a Bluetooth connection with a phone for the first time.

[Deleting Pairing Information from the Watch](#)

[④ Pair the watch with your phone](#)

## Creating Your Profile

Profile settings (weight, height, date of birth, gender, etc.) must be configured before the watch can display activity logs and calculate accurate heart rate zones.

1. Display the current time screen.  
[Watch Mode](#)
2. Hold down (C) for at least two seconds.  
This enters the Control Mode.
3. Use (C) to select [SETTING].



4. Press (A).  
This displays the setting menu screen.

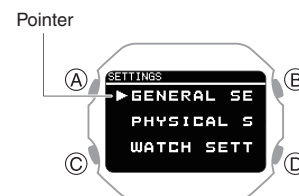

5. Use (C) to move the pointer to [PHYSICAL SETTINGS].

## 6. Press (A).

This displays the profile item selection screen.

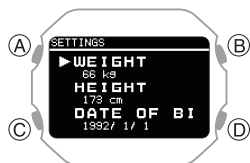

[WEIGHT]	Weight
[HEIGHT]	Height
[DATE OF BIRTH]	Date of birth
[SEX]	Gender
[WRIST]	Wrist where you wear the watch
[STRIDE RESET]	Stride reset
[TRAINING BACKGROUND]	Training frequency
[MAXIMUM HEART RATE]	Maximum heart rate
[RESTING HEART RATE]	Resting heart rate
[VO2MAX]	VO2MAX

7. Use (C) to move the pointer to the item you want to register.

8. Press (A).

9. Record your weight.

- On the profile item selection screen, select [WEIGHT].

① Use (C) to input your weight.

② Press (A) to register your weight. After the registration operation is complete, a check mark appears for a few seconds, and then the profile item selection screen re-appears.

10. Record your height.

- On the profile item selection screen, select [HEIGHT].

① Use (C) to input your height.

② Press (A) to register your height. After the registration operation is complete, a check mark appears for a few seconds, and then the profile item selection screen re-appears.

11. Specify your date of birth.

- On the profile item selection screen, select [DATE OF BIRTH].

① Use (C) to specify your birth year.

② Press (A).

③ Use (C) to specify your birth month.

④ Press (A).

⑤ Use (C) to specify your birth day.

⑥ Press (A) to register your date of birth. After the registration operation is complete, a check mark appears for a few seconds, and then the profile item selection screen re-appears.

12. Specify your gender.

- On the profile item selection screen, select [SEX].

① Use (C) to move the pointer to [MALE] (male) or [FEMALE] (female).

② Press (A) to register your gender. After the registration operation is complete, a check mark appears for a few seconds, and then the profile item selection screen re-appears.

13. Specify the wrist where you wear the watch.

- On the profile item selection screen, select [WRIST].

① Use (C) to move the pointer to [LEFT] (left) or [RIGHT] (right).

② Press (A) to register your wrist setting. After the registration operation is complete, a check mark appears for a few seconds, and then the profile item selection screen re-appears.

14. Reset the stride.

- This returns your stride to a value calculated based on your height.
- On the profile item selection screen, select [STRIDE RESET].

① Press (A) to reset the stride. After the reset operation is complete, a check mark appears for a few seconds, and then the profile item selection screen re-appears.

15. Registering your training frequency.

- On the profile item selection screen, select [TRAINING BACKGROUND].

① Use (C) to specify your training frequency.

Training frequency is an evaluation of your long-term physical activity level. Select the option that best describes the amount and intensity of your physical activity over the past three months.

[OCCASIONAL]	<ul style="list-style-type: none"> <li>Occasional (0 to 1 hour/week) Rare physical activity requiring heavy breathing or sweating.</li> </ul>
[REGULAR]	<ul style="list-style-type: none"> <li>Regular (1 to 3 hours/week) Regular physical activity such as running 5 to 10 km (3 to 6 miles) per week or equivalent physical activity for 1 to 3 hours per week. Could also be work that requires moderate physical activity.</li> </ul>
[FREQUENT]	<ul style="list-style-type: none"> <li>Frequent (3 to 5 hours/week) Running 20 to 50 km (12 to 31 miles) per week or engaging in strenuous exercise at least 3 times per week. Could also be equivalent physical activity of 3 to 5 hours per week.</li> </ul>
[HEAVY]	<ul style="list-style-type: none"> <li>Heavy (5 to 8 hours/week) Vigorous exercise 5 times or more per week, or training to improve competition performance.</li> </ul>

[SEMI-PRO]	<ul style="list-style-type: none"> <li>Semi-pro (8 to 12 hours/week) High-intensity physical exercise almost daily and exercise to improve athletic performance.</li> </ul>
[PRO]	<ul style="list-style-type: none"> <li>Pro (12 hours or more/week) Endurance athlete engaging in vigorous physical activity to improve competition performance.</li> </ul>

- ② Press (A) to exit training frequency registration.  
After the registration operation is complete, a check mark appears for a few seconds, and then the profile item selection screen re-appears.

## 16. Register a maximum heart rate.

- On the profile item selection screen, select [MAXIMUM HEART RATE].

- ① Use (C) to select a maximum heart rate registration method.

[AUTO]	Automatically sets a maximum heart rate based on your date of birth
[MANUAL]	Manual

- The currently selected setting is indicated by a check mark (☑) to the left.
- ② If you selected [MANUAL], use (C) to specify a maximum heart rate value.
- If you selected [AUTO], advance to step ③.
- ③ Press (A) to exit maximum heart rate registration.  
After the registration operation is complete, a check mark appears for a few seconds, and then the profile item selection screen re-appears.

## 17. This registers your resting heart rate.

- On the profile item selection screen, select [RESTING HEART RATE].

- ① Use (C) to select a resting heart rate registration method.

[AUTO]	Auto update
[MANUAL]	Manual

- The currently selected setting is indicated by a check mark (☑) to the left.
- ② If you selected [MANUAL], use (C) to specify a resting heart rate value.
- If you selected [AUTO], advance to step ③.
- ③ Press (A) to exit resting heart rate registration.  
After the registration operation is complete, a check mark appears for a few seconds, and then the profile item selection screen re-appears.

## 18. Register your VO2MAX.

- On the profile item selection screen, select [VO2MAX].

- ① Use (C) to select a VO2MAX registration method.

[AUTO]	Auto update
[MANUAL]	Manual

- The currently selected setting is indicated by a check mark (☑) to the left.

### Note

- With [AUTO], VO2MAX is calculated based on your profile.
- If you know your VO2MAX value as calculated by a breath gas analyzer or another device, select [MANUAL] and enter the value.

- ② If you selected [MANUAL], use (C) to specify a VO2MAX value.
- If you selected [AUTO], advance to step ③.

- ③ Press (A) to register your VO2MAX.  
After the registration operation is complete, a check mark appears for a few seconds, and then the profile item selection screen re-appears.

## 19. Press (D) twice to exit the setting screen.

## Mode Overview

Your watch has a Watch Mode and Activity Mode, and a Control Mode.

You can access the functions in each mode to perform measurements, view measurement results, and configure settings.

## Watch Mode

You can use the Watch Mode to access basic watch functions, body recovery support functions, and other functions and use them during your daily life.

To enter the Watch Mode from another mode, hold down (D) for at least one second.

- If activity measurement is in progress, you can switch to the Watch Mode by resetting the measurement and then holding down (D) for at least one second.



- Use (C) to select a function within a mode.

### ● Current Time Screen

Shows the current date and time.



### ● Notification Checking Function

This function lets you check calls, mail, SNS notifications, and other information that comes in on your phone.

[Receiving Phone Notifications](#)



### ● Heart Rate Measurement

This mode shows your current heart rate.

[Measuring Your Heart Rate](#)



### ● Blood Oxygen Level

This function measures your blood oxygen level.

[Blood Oxygen Level Measurement](#)



### ● Breathing Exercise (Breathing Exercise)

\* Powered by Polar

This mode supports stress reduction by guidance that promotes breathing at a slow and stable rhythm.

[Breathing Exercises](#)



### ● Stopwatch

Use this function to measure elapsed time.

[Stopwatch](#)



### ● Timer

The timer counts down from a start time specified by you. The watch performs a sound and/or vibration operation when the end of the countdown is reached.

[Timer](#)



### ● World Time

This function shows the current time in 38 cities around the globe and UTC (Coordinated Universal Time) time.

[World Time](#)



### ● Almanac (sunrise and sunset times, Moon age)

Use this function to check sunrise and sunset times, and the Moon age.

[Almanac \(Sunrise and Sunset Times, and Moon Age\)](#)



### ● Cardio Load Status (Cardio Load Status)

\* Powered by Polar

Use this function to keep track of your training status.

[Viewing Your Cardio Load Status](#)



### ● Life Log

Use this function to check Life Log data, such as your step count and calories burned.

[Viewing Life Log Data](#)



### ● Nightly Recharge™

\* Powered by Polar

Use this function to check your recovery status during sleep.

[Using Nightly Recharge™ to Check Your Recovery Status](#)



### ● Activity Log

Use this function to view recorded activity measurements.

[Viewing Activity Log Records](#)



## Activity Mode

In the Activity Mode, you can measure data for a selected training type or activity, and view the measurement results.

To enter the Activity Mode, press (A) while the current time screen is displayed.

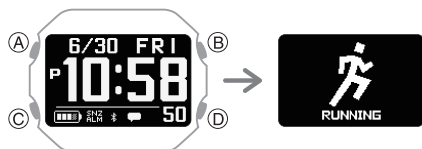

- Use (C) to select a function within a mode.

For information about activities, see the information below.

[Activity Overview](#)

## Control Mode

In the Control Mode, you can control various watch settings and communication with your phone.

To enter the Control Mode, hold down (C) for at least two seconds while the current time screen is displayed.

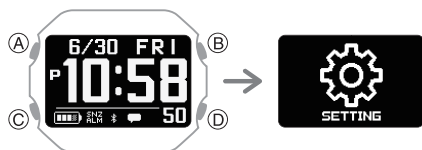

- Use (C) to select a function within a mode.

### SETTING

Use this function to configure watch settings.



- While the [SETTING] screen is displayed, pressing (A) displays the setting menu. For details about the settings, see the operating instructions for each function.

### Connect

You can use this function to reconnect manually with the phone that is paired with the watch.

[Connecting with a Phone Paired With the Watch](#)



### Phone Finder

You can use phone finder to trigger a sound on the phone that is paired with the watch to help you find it.

[Phone Finder](#)



### Time Adjustment

This function lets you acquire time data from the phone paired with the watch and adjust the watch's time setting with the press of a watch button.

[Manually Connecting with a Phone to Sync the Watch's Time Setting](#)



### Airplane Mode

You can use this function to turn the Airplane Mode on or off.

[Entering the Watch Airplane Mode](#)



## Performing Activity Measurement

The watch uses an accelerometer to measure and record the distance, step count, elapsed time, pace, and other data while running, walking, or engaging in other activities.

You can review recorded data on the watch or with CASIO WATCHES phone app.

[Viewing Activity Log Records](#)

Before using activity measurements, it is recommended that you configure the settings required for measurement.

[Activity Measurement Settings](#)



## Activity Overview

Your watch has four Activity Mode functions (activities).

- You can use CASIO WATCHES phone app to add, remove, or rearrange Activity Mode functions.

[Customizing the Watch Mode and Activity Mode Functions](#)

	<b>RUNNING (Running)</b> Performs running measurements.
	<b>WALKING (Walking)</b> Performs walking measurements.
	<b>GYM WORKOUT (Strength Training, etc.)</b> For workout measurements.
	<b>INTERVAL TIMER (Interval Timer)</b> You can use the interval timer for your training.

## Performing Activity Measurement

Use the procedures in this section to select an activity and measure it.

### ● To select an activity

1. Display the current time screen.

[Watch Mode](#)

2. Press (A).

This enters the Activity Mode.

**Example:**



3. Use (C) to select an activity.

- For information about activity items, see the information below.

[Activity Overview](#)

### ● To start measurement

1. Press (A).

This starts activity measurement.



- This displays a screen of the measurement being performed for the activity you specified with CASIO WATCHES phone app.

During activity measurement, use (C) to scroll between measurement screens.

[Configuring Activity Measurement Display Settings](#)

### To pause an ongoing activity measurement

Press (A). To resume a paused activity measurement, press (A) again.

### ● To end activity measurement

1. While an activity measurement operation is in progress, press (A).

This pauses activity measurement and opens the paused menu screen.

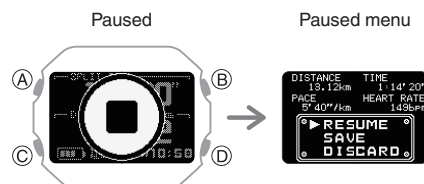

- While the paused menu screen is displayed, press (D) to display a measurement screen. While a measurement screen is displayed, use (C) to scroll between screens.

To return to the paused menu screen, press (D).

[RESUME]	Resumes timing.
[SAVE]	Saves the data and ends the measurement.
[DISCARD]	Ends the measurement without saving the data.

2. Use (C) to select [SAVE].

3. Press (A).

- This displays the activity measurement result.

- You can use (C) to scroll between summary screens.

The display returns to the current time after a preset amount of time or when (D) is pressed.

- If a measurement operation is terminated without saving the data, the display returns to the selected activity screen.

### ● To measure lap times

1. This starts activity measurement.

[To start measurement](#)

2. Press (D).

Each press of (D) displays the elapsed time of the current section (lap time) to appear.

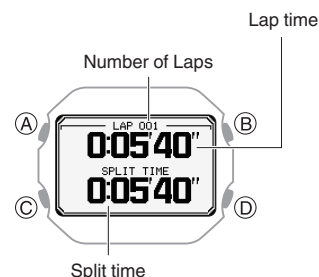

3. Press (A) to pause activity measurement.

[To end activity measurement](#)

## Using the Timer for Interval Training

### Overview

Multiple timers can be used for the timing of consecutive segments of an activity (interval timers). You can use an interval timer to control how much time you spend doing push-ups, squats, or other exercises that make up a fitness workout.

For example, you could configure an interval timer as shown below and have intervals ① through ④ automatically repeat ten times.

### Timer Settings

- [TIMER1]: 30 seconds
- [TIMER2]: 20 seconds
- [TIMER3]: 30 seconds
- [TIMER4]: 25 seconds
- Sets: 10

### Interval Training Workout

- ① Push-ups: 30 seconds
- ② Rest: 20 seconds
- ③ Squats: 30 seconds
- ④ Rest: 25 seconds

### Note

- The interval timer can repeat up to five timers up to ten times (auto repeat timer).
- For information about configuring interval timer settings, see the information below.
  - 🔗 [Configuring Interval Timer Settings](#)

## Timing with Interval Timers

1. Display the current time screen.
  - 🔗 [Watch Mode](#)
2. Press (A).
3. Use (C) to select [INTERVAL TIMER].



4. Press (A).
  - This displays the measurement operation ready screen.



5. Press (A) to start the timer countdown.



- A 10-second sound or vibration alert notifies you when the interval timer operation is complete.
6. Press any button to stop the sound and/or vibration operation.
    - This displays the summary (measurement result) screen.
    - After the interval timer end notification, the watch automatically stores the measurement data and displays the summary (measurement result) screen.

### Note

- Interval timers count down the final five seconds with sound/vibration.
- Holding down (D) for at least one second while a timer operation is in progress stops the current timer and starts measurement with the next timer.

## Pausing and Resetting the Timer

1. While a timer operation is in progress, press (A).
  - This pauses the time operation. After a few seconds, the pause menu screen appears.

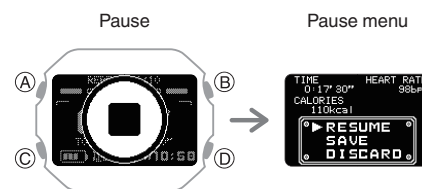

2. Use (C) to select what to do with the interval training data measured by the timer.

[RESUME]	Resumes the timer operation.
[SAVE]	Saves the data and ends the timer operation.
[DISCARD]	Resets the timer.

3. Press (A).
  - If you selected [SAVE], your interval training results appear on the display. You can use (C) to scroll between summary screens. Press (D) to return to the current time screen.

## Starting Heart-rate Training

With heart-rate training, you measure your heart rate and then use the resulting value as a benchmark for training. You can monitor your heart rate levels and keep your exercise intensity in line with your training goals, which contributes to more efficient training, improved cardiopulmonary function, and better health.

\* Heart Rate Zone (HR zones)  
Powered by Polar

### To specify a target heart rate zone

Specify a target heart rate zone that matches your training objectives.

The range from 50% to 100% of your maximum heart rate is divided into five heart rate zones. You can easily control the intensity of your training by keeping your heart rate within a particular zone. Each heart rate zone has a main effect, and understanding these effects can enhance the effectiveness of your training.

- Zone 1 (50 to 60% of maximum heart rate):  
Very light training  
Zone 1 training improves overall health and helps you recover from more strenuous training.  
You can continue training in this zone for long periods.
- Zone 2 (60 to 70% of maximum heart rate):  
Light training  
Zone 2 training increases general stamina. It uses fat as an energy source, improving the body's ability to burn fat.  
You can continue training comfortably in this zone for long periods.
- Zone 3 (70 to 80% of maximum heart rate):  
Moderate training  
Zone 3 training improves aerobic fitness. It causes lactic acid to begin to accumulate in the bloodstream, but the body can reuse the lactic acid for energy, so it does not affect performance.  
Since Zone 3 training requires deeper breathing, you will feel the need for a moderate amount of effort.

- Zone 4 (80 to 90% of maximum heart rate):  
Hard training  
Zone 4 training improves speed endurance and enhances the ability of the body to use protein (sugar) for energy. In addition, Zone 4 training allows you to tolerate high levels of lactic acid in the blood.  
Zone 4 training results in muscle fatigue and rough breathing.

- Zone 5 (90 to 100% of maximum heart rate):  
Very hard training  
Zone 5 training improves maximum performance. Large amounts of lactic acid are accumulated, so long-term training is not possible.  
Zone 5 training results in labored breathing and muscle fatigue.

1. Configure CASIO WATCHES phone app settings so the heart rate measurement screen is displayed as an activity measurement screen.

[Configuring Activity Measurement Display Settings](#)

2. Display the current time screen.

[Watch Mode](#)

3. Press (A).

This enters the Activity Mode.

**Example:**



4. Use (C) to select an activity.

5. Press (A).

6. Use (C) to select the heart rate measurement screen.



7. Hold down (C) for at least two seconds.

This displays the HEART RATE (heart rate measurement) setting screen.

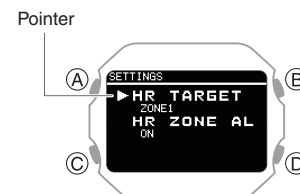

8. Use (C) to move the pointer to [HR TARGET ZONE].

9. Press (A).

10. Use (C) to move the pointer to the heart rate zone you want to specify as your target.

11. Press (A) to complete the setting operation.

After the setting operation is complete, a check mark appears for a few seconds, and then the HEART RATE (heart rate measurement) function setting screen reappears.

12. Press (D) to exit the setting screen.

## ● To set up the heart rate zone alert

If you engage in heart-rate training while the heart rate zone alert is enabled, the watch will perform a sound and/or vibration operation to let you know when your current heart rate is outside your target zone. If you do not re-enter the target zone after the alert, an out-of-zone notification operation will be performed at one-minute intervals.

Heart rate zone alert performs notification only while the heart rate measurement screen is displayed.

1. Configure CASIO WATCHES phone app settings so the heart rate measurement screen is displayed as an activity measurement screen.

[Configuring Activity Measurement Display Settings](#)

2. Display the current time screen.

[Watch Mode](#)

3. Press (A).

This enters the Activity Mode.

**Example:**



4. Use (C) to select an activity.

5. Press (A).

6. Use (C) to select the heart rate measurement screen.



7. Hold down (C) for at least two seconds.

This displays the HEART RATE (heart rate measurement) setting screen.

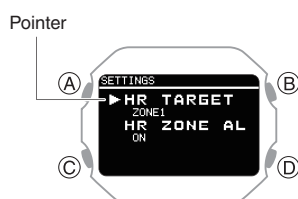

8. Use (C) to move the pointer to [HR ZONE ALERT].

9. Press (A).

10. Use (C) to move the pointer to [ON] (enabled) or [OFF] (disabled).

11. Press (A) to complete the setting operation.

After the setting operation is complete, a check mark appears for a few seconds, and then the HEART RATE (heart rate measurement) function setting screen reappears.

12. Press (D) to exit the setting screen.

## Activity Measurement Precautions

- After using an activity function, use the charging cable to charge the watch. [Charging the Watch](#)
- Activity measurement is not possible while the battery indicator shows **LOW** or lower. Charging before performing an activity measurement is recommended. [Charging](#)
- If [MEMORY FULL] appears on the display while an activity measurement operation is in progress, the measurement operation stops. Measurement also stops automatically whenever a single activity measurement operation exceeds 80 hours.



- You may not be able to save measurement results if the remaining activity log capacity is low. If this happens, delete log data you no longer need to make room for more data.

[Deleting Activity Records](#)



- For information about the summary (Measurement Result) screen that appears after an activity measurement operation is complete, see the information below.

[Viewable Activity Log Items](#)

## Viewing Activity Log Records

After an activity measurement operation is completed, a summary (measurement results) is displayed and saved in watch memory as log data.

There is enough memory to store up to 100 log records.

### Measurement Data Accuracy

- The sensors of your watch calculate your step count, calories burned, heart rate, running index (when phone GPS is used), and other data. No guarantees are made concerning the accuracy of the statistics and values calculated by this watch, so they should be used as general reference information only.

## Viewable Activity Log Items

The summaries (measurement results) in the table below can be viewed after an activity measurement is complete or by accessing the activity log.

The summary screens that are displayed depend on the activity.

Activity	Summary (Measurement Result) Screen
RUNNING	Measurement Result Details Heart Rate Calories burned Cadence Pace Lap
WALKING	Measurement Result Details Heart Rate Calories burned Cadence Speed Lap
GYM WORKOUT	Measurement Result Details Heart Rate
INTERVAL TIMER	Calories burned Segments

### ● Summary Screen Details Measurement Result Details Summary



- Activity name
- Split time
- Running distance
- Activity start date and time
- Pace

## Heart Rate Summary

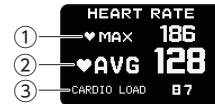

- Maximum heart rate
- Average heart rate
- Cardio load \*1

\*1 Cardio Load (CARDIO LOAD)  
Powered by Polar

Cardio load measures the load your training session places on your cardiovascular system. Cardio load measurement values are displayed up to 999. The CASIO WATCHES phone app shows values greater than 999.

## Burned calorie summary

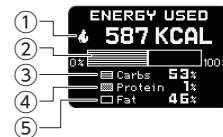

- Calories burned during measurement period
- Graph
- Carbohydrate percentage
- Protein percentage
- Fat percentage

\* Analysis of Energy Consumption by Three Major Nutrients

Energy source used (Energy Used)  
Powered by Polar

The energy sources used breakdown shows how much of each energy source (fats, carbs, protein) you used during your session. These are indicated as percentages of the total calories burned. If the heart rate sensor is not being used, the calories burned are output but the energy source used is not output.

## Cadence Summary

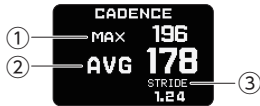

- ① Maximum cadence
- ② Average cadence
- ③ Average Stride

## Pace Summary



- ① Best pace
- ② Average pace
- ③ Running index \*2
- ④ Evaluation \*3

\*2 Running index (RUNNING INDEX)

Powered by Polar

The Running Index provides your maximal aerobic fitness when running. This calculation is calculated for each run based on your heart rate and speed data measured during the run.

This item is displayed only when RUNNING is selected as the activity and you are using your phone GPS.

\*3 The evaluation is shown as one of the following: VERY LOW (Very Low), LOW (Low), FAIR (Fair), MODERATE (Moderate), GOOD (Good), VERY GOOD (Very Good), ELITE (Elite).

You can also check age-specific reference values.

[Fitness Categories](#)

## Speed Summary



- ① Average speed

## Lap Summary



- ① Number of Laps

## Segment Summary



- ① Segment repeats

## Viewing Activity Records

You can view recorded activity log data on the watch or with the CASIO WATCHES phone app.

### ● To view activity records with the CASIO WATCHES phone app

#### Check the connection

- Make sure the symbol is shown on the watch display when you perform the procedure below. If is not displayed, refer to the information at the link below.

[Connecting with a Phone Paired With the Watch](#)

1. Tap the "CASIO WATCHES" icon.
2. Tap the "My Page" tab.
3. Scroll the screen and then tap the history of the activity whose data you want to view.

### ● To view activity records with the watch

1. Display the current time screen.  
[Watch Mode](#)
2. Use (C) to select [ACTIVITY LOG].



3. Press (A).  
This displays the activity log list.

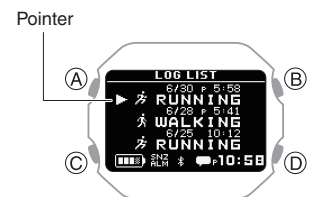

4. Use (C) to move the pointer to the log data record you want to view.

5. Press (A).

This displays the detailed summary screens of the selected log data.



6. Use (C) to display the summary screen you want to view.

- For details about summary screens, see the information below.

[Viewable Activity Log Items](#)

- To view the details of individual lap data, press (A) while a lap summary or segment summary screen is displayed.

7. To return to the activity log list screen, press (D).

## Note

- Pressing (D) during the above procedure will go back one screen.

## Deleting Activity Records

### Deleting Specific Data

1. Display the current time screen.

[Watch Mode](#)

2. Use (C) to select [ACTIVITY LOG].



3. Press (A).

This displays the activity log list.

Pointer



4. Use (C) to move the pointer to the data you want to delete.

5. Press (A).

This displays the detailed summary screen of the selected log data.

6. Hold down (C) for at least two seconds.

This displays a delete menu.

7. Use (C) to move the pointer to [YES].

To cancel log data deletion, move the pointer to [NO].

8. Press (A).

After the data delete operation is complete, a check mark appears for a few seconds, and then the activity log list screen re-appears.

9. Press (D) twice to return to the current time screen.

## Deleting All Activity Data

1. Display the current time screen.

[Watch Mode](#)

2. Use (C) to select [ACTIVITY LOG].



3. Press (A).

This displays the activity log list.

Pointer



4. Hold down (C) for at least two seconds.

This displays a delete menu.

5. Use (C) to move the pointer to [YES].

To cancel log data deletion, move the pointer to [NO].

6. Press (A).

After the data delete operation is complete, a check mark appears for a few seconds, and then [NO DATA] appears.

7. Press (D) twice to return to the current time screen.

## Viewing Your Training Performance Condition

You can use your watch to measure your heart rate and running speed, and display your cardio load status.

### Important!

- To measure your cardio load status, you need to measure your heart rate and set up your profile.
  - [Using Heart Rate Measurement](#)
  - [Creating Your Profile](#)

## Viewing Your Cardio Load Status

The cardio load status compares your load (STRAIN) with your endurance (TOLERANCE) to see how your training is affecting your body. You can control your total training volume in the short and long term by checking your cardio load status.

\* Cardio Load Status (Cardio Load Status)  
Powered by Polar

- Display the current time screen.
  - [Watch Mode](#)
- Use (C) to select [CARDIO STATUS].



- Press (A).

This displays the cardio load status screen.

- The message [NO DATA] appears if there is no data available.



### ① Cardio load status

[DETRAINING]	<ul style="list-style-type: none"> <li>&lt; 0.8 Training at a load that is less than recommended has continued for one week or longer, which is affecting your fitness level. Correct by increasing your training load.</li> </ul>
[MAINTAINING]	<ul style="list-style-type: none"> <li>0.8 to 1.0 Training load suitable for maintaining your fitness level. For better effect, try other types of training or increase the training volume.</li> </ul>
[PRODUCTIVE]	<ul style="list-style-type: none"> <li>1.0 to 1.3 Maintain this status. The training load is either laying a foundation for fitness or guiding you in the right direction for fitness. To maintain this status, schedule recovery time between training.</li> </ul>
[OVERREACHING]	<ul style="list-style-type: none"> <li>&gt; 1.3 This status has a high training load, which is counterproductive. Rest is required. Create recovery time by including low-load training.</li> </ul>

- The displayed value is calculated by dividing the strain by the tolerance.

### ② Strain

Shows the load of your most recent training.

This value shows the average daily load for the past seven days.

### ③ Tolerance

Shows how ready you are to endure cardio-strength training.

This value shows the average daily load for the past 28 days.

- Press (D) twice to return to the current time screen.

### Note

- At least three days of activity measurements within the past 28 days are required to display your cardio load status.
- Your cardio load status is updated after you activate the heart rate measurement and perform an activity measurement, or every day at midnight (12:00 am).

## Using Nightly Recharge™ to Check Your Recovery Status

With Nightly Recharge™, you can check how much you have recovered from the load placed on your body during the day.

The Nightly Recharge™ status is based on two factors: Sleep Charge (the quality of your sleep) and ANS Charge (how calm your autonomic nervous system is during the early hours of your sleep).

\* Nightly Recharge™  
Powered by Polar



### Important!

- Wearing the watch for long periods, sweat, or certain usage environments create the risk of skin rash. To prevent skin problems, regularly remove your watch from your wrist to give your skin some time to rest.

## Checking Nightly Recharge™ Status

- Display the current time screen.

Watch Mode

- Use (C) to select [NIGHTLY RECHARGE].



- Press (A).

This displays the Nightly Recharge™ status summary screen.

- The message [NO DATA] appears if there is no data available.

Each press of (C) switches screen contents as described below.

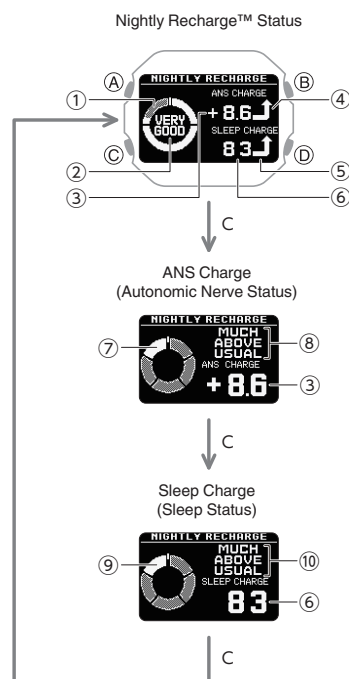

- Indicator level
- Nightly Recharge™ Status
- ANS Charge Score
- Status Icons (ANS Charge)
- Status Icons (Sleep Charge)
- Sleep Charge Score
- Autonomic nerve status
- ANS Charge Status
- Sleep status
- Sleep Charge Status

### Note

- In the following situations, sleep data cannot be acquired, so [NO DATA] is shown on the display, or the accuracy of sleep analysis may be decreased.
  - Sleep (from bedtime to wake up) of less than 4 hours
  - Constantly moving or barely moving during sleep
  - Wearing the watch only while asleep and taking it off immediately after awaking
- Nightly Recharge™ can be used when the conditions below are satisfied.
  - Heart rate measurement is set to [ON] or [ACTIVITY & NIGHT TIME ON], enabling continuous heart rate measurement.
  - Using Heart Rate Measurement**  
With [ACTIVITY & NIGHT TIME ON], sleep measurement starts from the time set for NIGHT TIME. For the NIGHT TIME time setting, specify your normal sleep time (bedtime and wake-up time).
    - The watch is firmly attached to your wrist when you go to bed.
    - At least three sleep measurements in the past 28 days (one of which was the night before)
  - To improve sleep analysis accuracy, it may take about one to two hours after you wake up for measurement results to be displayed on the watch.

### ● To interpret a status

#### Nightly Recharge™ Status

[VERY GOOD]	Very Good
[GOOD]	Good
[OK]	OK
[COMPROMISED]	Compromised
[POOR]	Poor
[VERY POOR]	Very Poor

## ANS Charge (Autonomic Nerve Status)

This function quantifies to how much your autonomic nerve system calms down during the night.

Score range: -10 to 10

Score		Status
-6 or below		[MUCH BELOW USUAL] (Much Below Usual)
-6 to -2		[BELOW USUAL] (Below Usual)
-2 to 2		[USUAL] (Usual)
2 to 6		[ABOVE USUAL] (Above Usual)
6 or above		[MUCH ABOVE USUAL] (Much Above Usual)

## Sleep Charge (Sleep Status)

This function evaluates and quantifies your sleep time and sleep status.

Your score and index are determined by comparing the previous night's sleep to your average score for the previous 28 days.

Score range: 1 to 100

Score		Status
-10 or less of average		[MUCH BELOW USUAL] (Much Below Usual)
-3.33 to -10 of average		[BELOW USUAL] (Below Usual)
± 3.33 of average		[USUAL] (Usual)
+3.33 to +10 of average		[ABOVE USUAL] (Above Usual)
+10 or more of average		[MUCH ABOVE USUAL] (Much Above Usual)

## Breathing Exercises

The breathing exercise function provides guidance for deep breathing exercises. The guidance teaches you how to breathe slowly and at a stable rhythm.

Breathing exercises help you relax your body and mind, and deal with stress.

\* Breathing Exercise (Breathing Exercise)  
Powered by Polar



## Setting a Breathing Exercise Duration

Use this procedure to set the duration (in minutes) of the breathing exercise.

Setting range: 02'00" to 20'00"

1. Display the current time screen.  
 Watch Mode
2. Use (C) to select [BREATHING EXERCISE].



3. Press (A).

This displays the breathing exercise reset screen.



4. Hold down (C) for at least two seconds.

This displays the breathing exercise duration setting screen.



5. Use (C) to change the duration (minute) setting.
  - You can set a time from 2 to 20 minutes in 1-minute increments.
6. Press (A) to complete the setting operation.

After the setting operation is complete, a check mark appears for a few seconds, and then the breathing exercise reset screen re-appears.

### Note

- While the setting is being configured, the watch will exit the setting operation automatically after about two or three minutes of non-operation.

## Measuring a Breathing Exercise

During your breathing exercise, the watch measures the time you spend in the calm zone (the time you spend breathing slowly so your breathing rhythm and your heart are in sync with each other).

Keep your arms still during breathing exercise measurement.

1. Display the current time screen.  
 Watch Mode

2. Use (C) to select [BREATHING EXERCISE].



3. Press (A).

This displays the breathing exercise reset screen.

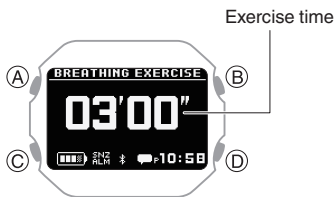

4. Sit or lie down.

Relax your arm and adjust your posture so you can keep your hand still.

5. Press (A).

This displays the breathing exercise preparation screen.



After the preparation is completed, the watch starts breathing exercise measurement.

6. Breathe slowly (inhale and exhale) according to the animation.

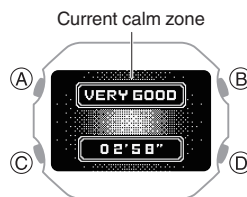

Calm zone	Meaning
(No display)	Good zone not reached.
[GOOD]	Good
[VERY GOOD]	Very Good
[OPTIMAL]	Optimal

After the measurement operation is complete, the watch displays the result.

- Each press of (C) cycles to the next screen.

Result 1	Result 2
Measurement start date and time	Time in each calm zone
Elapsed time	

### Note

- To reach the [OPTIMAL] zone, maintain a pace of six breaths (inhale, exhale) per minute.
- [ERROR] appears on the display if you remove the watch from your wrist while the preparation screen is displayed or if a stable signal cannot be obtained.

## Smart Alarm

The smart alarm uses the watch's accelerometer and heart rate sensor to estimate your sleep state and notify you by a 10-second sound or vibration operation when your sleep is light during a specified period.

For example, if you set an alarm time of 7:30 and a smart period of 60 minutes, the alarm alerts you to a good time to awake between the hours of 6:30 and 7:30.

### Important!

- Make sure you leave the watch affixed to your wrist when using the smart alarm.



## Note

- To use the smart alarm, select [ON] or [ACTIVITY & NIGHT TIME ON] for heart rate measurement to enable continuous heart rate measurement. When [OFF] is selected for heart rate measurement, the smart alarm functions as a normal alarm.
  - [Using Heart Rate Measurement](#)
- Note that no guarantees how you will feel when you wake up by the smart alarm. Depending on your physical makeup and condition, the watch may not be able to determine your sleep state accurately.
- The smart alarm is a function that helps you wake up. It does not improve your sleep quality. To improve your sleep quality, you need to adjust your life rhythm and ensure you get enough sleep.
- Sleeping for shorter periods can cause sleep status measurement to be less accurate.
- Your sleep state cannot be determined if your sleep time, excluding the alarm time, is less than two hours. The watch performs a sound and/or vibration operation when the alarm time is reached.
- You can enable or disable sound and vibration alert as required.
  - [Configuring Sound and Vibration Settings](#)
- Sound and vibration alert is not performed while the battery indicator is "CHG" or lower.
- For information about using an alarm for a purpose other than waking up, see the information below.
  - [Alarm](#)

## Configuring Smart Alarm Settings

Use the CASIO WATCHES phone app or watch operations to configure smart alarm settings.

### ● To configure smart alarm settings with the CASIO WATCHES phone app

#### Check the connection

- Make sure the symbol is shown on the watch display when you perform the procedure below. If is not displayed, refer to the information at the link below.
  - [Connecting with a Phone Paired With the Watch](#)

- Tap the "CASIO WATCHES" icon.
- Tap the "My Watch" tab.
- Select "DW-H5600" and tap it.
- Select the setting you want to change and then perform the operation shown on the screen.

### ● To configure smart alarm settings with the watch

- Display the current time screen.
  - [Watch Mode](#)
- Hold down (C) for at least two seconds. This enters the Control Mode.
- Use (C) to select [SETTING].



- Press (A). This displays the setting menu screen.

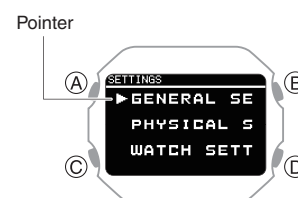

- Use (C) to move the pointer to [WATCH SETTINGS].
- Press (A). This displays the watch setting screen.
- Use (C) to move the pointer to [SMART ALARM].
- Press (A).

9. Use (C) to select the smart alarm and snooze function ON/OFF setting you want.

[OFF]	Disables smart alarm, disables snooze
[ON]	Enables smart alarm, disables snooze
[ON (SNZ)]	Enables smart alarm, enables snooze

- The snooze function on/off setting you configure is for the smart alarm only.
- The currently selected setting will be indicated by a check mark (✓) to the left.

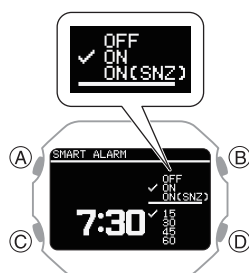

10. Press (A).

11. Use (C) to set the alarm time hour.

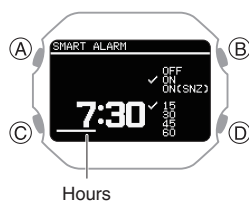

12. Press (A).

This causes the cursor to move to the minute setting of the time.

13. Use (C) to set the alarm time minute.

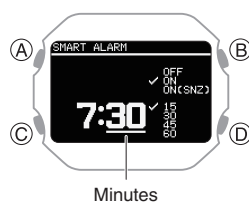

14. Press (A).

This moves the cursor to the smart period setting.

- A smart alarm sounds when the watch determines you are lightly asleep during the smart period.

15. Use (C) to specify a smart period setting.

[15]	From 15 minutes before alarm time, to alarm time
[30]	From 30 minutes before alarm time, to alarm time
[45]	From 45 minutes before alarm time, to alarm time
[60]	From 60 minutes before alarm time, to alarm time

- The currently selected setting will be indicated by a check mark (✓) to the left.

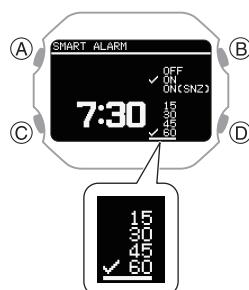

### Note

- The shorter the smart time period, the higher the probability that the alarm will sound at the alarm time.

16. Press (A) to complete the setting operation.

After the setting operation is complete, a check mark appears for a few seconds, and then the watch setting screen reappears.

- You can view the setting time of the smart alarm and whether the smart alarm setting and snooze setting are on or off.

17. Hold down (D) for at least one second to return to the current time screen.

### Note

- If you do not perform any operation for two or three minutes while the smart alarm setting screen is displayed, the watch automatically returns to the current time screen.

## Turning Off Smart Alarm

1. Display the current time screen.  
[Watch Mode](#)
2. Hold down (C) for at least two seconds.  
 This enters the Control Mode.
3. Use (C) to select [SETTING].



4. Press (A).  
 This displays the setting menu screen.

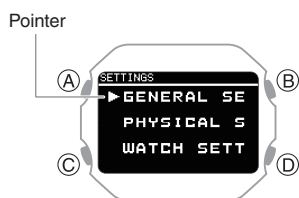

5. Use (C) to move the pointer to [WATCH SETTINGS].
6. Press (A).  
 This displays the watch setting screen.
7. Use (C) to move the pointer to [SMART ALARM].
8. Press (A).
9. Use (C) to select [OFF].
10. Press (A) to complete the setting operation.  
 After the setting operation is complete, a check mark appears for a few seconds, and then the watch setting screen reappears.
11. Hold down (D) for at least one second to return to the current time screen.

### Note

- If you do not perform any operation for two or three minutes while the smart alarm setting screen is displayed, the watch automatically returns to the current time screen.

## Measuring Your Heart Rate

While wearing the watch on your wrist, you can use it to perform approximate measurement of your heart rate.

You can use heart rate measurements to monitor your daily health and to make your training more effective.



### Important!

- For more accurate measurement results, configure your profile settings before using the heart rate measurement function.  
[Creating Your Profile](#)
- Be sure to affix the watch to your wrist before starting a heart rate measurement operation. Starting a measurement operation and then affixing the watch to your wrist may make correct measurement impossible.

## Checking Your Current Heart Rate

The HEART RATE (heart rate measurement) function lets you check your current heart rate.

1. Display the current time screen.  
[Watch Mode](#)
2. Use (C) to select [HEART RATE].



3. Press (A).  
 This displays the current heart rate screen.

- Each press of (C) toggles between the value screen and graph screen.

### Value Screen

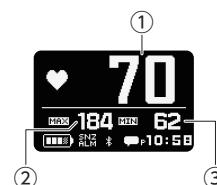

## With heart rate graph

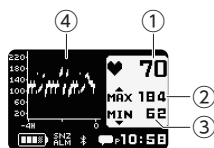

- ① Current heart rate
- ② Maximum heart rate  
Current day's high heart rate
- ③ Minimum heart rate  
Current day's low heart rate
- ④ Heart rate graph
  - The heart rate graph shows data for up to eight hours.
  - One division of the heart rate graph shows the range of maximum and minimum values measured over four minutes.

### Note

- If you do not perform any operation for about one hour while using the HEART RATE (heart rate measurement) function, the watch will return to the current time screen.

## Using Heart Rate Measurement

During heart rate measurement, your current heart rate is shown on other screens besides the HEART RATE (heart rate measurement) function screen.

- For more accurate display values, create your profile before using heart rate measurement.  
[🔗 Creating Your Profile](#)

### ● To enable or disable heart rate measurement

While heart rate measurement is enabled, the watch displays your current heart rate.

1. Display the current time screen.  
[🔗 Watch Mode](#)
2. Hold down (C) for at least two seconds.  
This enters the Control Mode.
3. Use (C) to select [SETTING].



4. Press (A).  
This displays the setting menu screen.

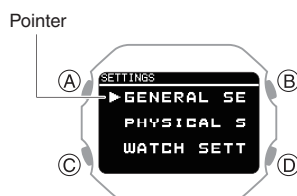

5. Use (C) to move the pointer to [GENERAL SETTINGS].
6. Press (A).
7. Use (C) to move the pointer to [HR TRACKING].
8. Press (A).  
This displays the heart rate measurement enable/disable screen.

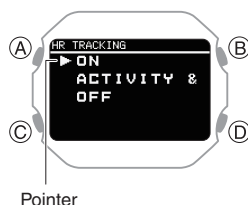

9. Use (C) to select ON/OFF setting.

[ON]	Enables heart rate measurement
[ACTIVITY & NIGHT TIME ON]	Enables heart rate measurement during activity measurement, within the specified night time only
[OFF]	Disables heart rate measurement

10. Press (A) to complete the setting operation.

After the setting operation is complete, a check mark appears for a few seconds, and then the GENERAL SETTINGS screen re-appears.

11. Hold down (D) for at least one second to return to the current time screen.

### Note

- Even if heart rate measurement is set to [OFF], your heart rate is displayed by the HEART RATE (heart rate measurement) function.
- Available functions and battery consumption depend on the heart rate measurement settings. Configure settings to suit your specific needs.
  - [ON]: Enables full use of the functions of your watch: heart rate measurement during the day, accurate calories burned measurement and sleep measurement at night. Battery consumption is high with this setting.
  - [ACTIVITY & NIGHT TIME ON]: Performs measurement during activities and at night (Sleep Measurement) only. Heart rate measurement during the daytime and other functions are limited. Battery consumption is moderate with this setting. For information about configuring night time settings, see the information below.  
[🔗 Specifying the Night Time](#)
  - [OFF]: Heart rate measurement is not performed with this setting. Accurate calories burned measurement, sleep, running index, cardio load, and other functions are limited. Battery consumption is low with this setting.

## Heart Rate Measurement Precautions

### Heart Rate Measurement Functions

- The back cover of the watch has a built-in sensor that detects your pulse. This is used to calculate and display an approximate heart rate value. The factors below can cause error in the displayed heart rate value.
  - How the watch is affixed to the wrist
  - Individual wrist characteristics and condition
  - Training type and/or intensity
  - Sweat, dirt, and/or other foreign matter around the sensor
- All of this means that heart rate values displayed by the watch are approximate, and no guarantees are made concerning their accuracy.
- The conditions below may make accurate pulse detection impossible.
  - Exercising in a low-temperature environment or under other conditions that reduce blood flow
  - Arm tattoos
  - Use of sunblock cream or lotion, insect repellent, etc.
- The heart rate measurement function of this watch is intended for recreational purposes, and should not be used in any way for medical purposes.
- Heart rate measurement is automatically disabled when the battery level indicator shows or lower.

### Movements that Affect Heart Rate Measurement

- Activities that involve vigorous movement of the arms only or other certain movements\* may affect heart rate measurement and cause errors in the heart rate data displayed by the watch.
  - \* Activities involving vigorous wrist movements or wrist rolling such as playing a percussion instrument, tennis, etc.

### Warming Up Before Training

- Weak blood circulation due to low temperatures or cold hands may affect heart rate measurement.
- When performing training that involves heart rate measurement, make sure to warm up appropriately.

### Measurement while [ON] is selected for the heart rate measurement setting

While [ON] is selected for the heart rate measurement setting, your heart rate is measured intermittently (every two minutes). If the watch determines that you are performing some activity (based on behavior analysis by the acceleration sensor), heart rate measurement will be performed continuously (every second).

## Blood Oxygen Level Measurement

Your watch can measure your blood oxygen level.

A normal blood oxygen level is said to be 95% to 100%, but this varies depending on your activity level and physical condition.

### Note

- Note that values displayed by this watch are for reference only. Should you feel any abnormalities, consult with your doctor immediately.

### Important!

- Before starting a blood oxygen level operation, be sure to affix this watch to your wrist. Starting a measurement operation and then affixing the watch to your wrist may make correct measurement impossible.
- The blood oxygen level measurement function is not intended as a medical device for diagnosing specific diseases. It is intended for general health maintenance only.

## Measuring Your Blood Oxygen Level

### Important!

- It may not be possible to obtain blood oxygen level measurement results if you are in a cold location and your wrist is cold. Warm your wrist before attempting measurement.
- If measurement at the same location on your wrist fails continuously or if measured values fluctuate widely, change the location on your wrist where you are wearing the watch. You can also try moving the watch to your opposite wrist for measurement.
- Take several measurements under identical conditions, moving the watch around your wrist. Find the wrist location where measurement is most stable.
- Do not take measurements immediately after exercising. Wait until your breathing stabilizes.
- During measurement, keep your arm still and do not move it.
- During measurement, refrain from talking and do not hold your breath.

1. While seated, place your arm on a table or some other flat surface.
2. Keep your elbow and wrist as unbent and straight as possible.

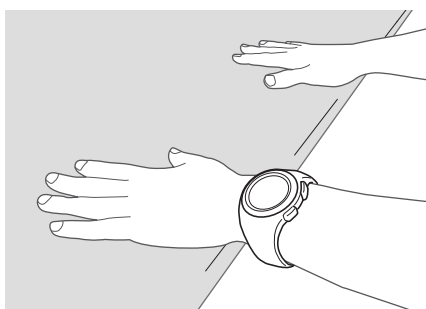

3. Make sure the band is not contact with the surface below your arm and not pressed against your wrist.
4. Display the current time screen.  
[Watch Mode](#)
5. Use (C) to select [BLOOD OXYGEN].



6. Press (A).  
This displays the blood oxygen level measurement screen.



7. Press (A).  
Start blood oxygen level measurement.



The measurement result is displayed after a blood oxygen level measurement operation is complete.

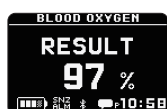

8. Hold down (D) for at least one second to return to the current time screen.

### Note

- The message [ERROR] appears on the display if a blood oxygen level measurement error occurs.
- The message [- - %] appears on the display if the measured value is outside the allowable measurement range.
- The watch automatically returns to the current time screen if you do not perform any operation for about one hour while using the blood oxygen level measurement function.

## Pedometer

You can use the pedometer to keep track of your step count while walking, running, engaging in your normal daily activities, etc.



### Counting Steps

If you are wearing the watch correctly, the pedometer counts your steps as you walk, run, or engage in your normal daily activities.

#### Important!

- Since this watch is a wrist-worn device, it may detect non-step movements and count them as steps. Also, abnormal arm movements while walking may cause a miss count of steps.

#### ● Getting Ready

To enable the most accurate step count, wear the watch with the face on the outside of your wrist and tighten the band securely. A loose band may make it impossible to obtain correct measurement.



#### ● Counting Steps

The pedometer will start counting your steps when you start walking.

#### ● To check the step count

You can check your step count on the watch's current time screen, with the Life Log function or with the CASIO WATCHES phone app.

- 🔗 [Specifying a Watch Face](#)
- 🔗 [Viewing Life Log Data](#)

#### Note

- The step count can show a value up to 99,999 steps. [----] is displayed when the step count exceeds 99,999.
- To avoid miscounting of non-walking movements, the step count is not displayed immediately after you start moving.
- The step count is reset to zero at midnight each day.
- The watch can store up to three days of step counts.
- Step count results are transferred to the CASIO WATCHES phone app when the watch is connected to the app or when the app is started up.
- You can also use the CASIO WATCHES phone app to specify a daily step target.
  - 🔗 [Specifying a Daily Step Count Target](#)

## Causes of Incorrect Step Count

Certain conditions may make correct step counting impossible.

#### Important!

Any of the conditions below may make proper counting impossible.

- Walking while wearing slippers, sandals, or other footwear that encourages a shuffling gait
- Walking on tile, carpeting, snow, or other surface that causes a shuffling gait
- Irregular walking (in a crowded location, in a line where walking stops and starts at short intervals, etc.)
- Extremely slow walking or extremely fast running
- Pushing a shopping cart or baby stroller
- In a location where there is a lot of vibration or riding on or in a vehicle
- Frequent movement of the hand or arm (clapping, fanning movement, etc.)
- Walking while holding hands, walking with a cane or stick, or engaging in any other movement in which your hand and leg movements are not coordinated with each other
- Normal daily non-walking activities (cleaning, etc.)
- Wearing the watch on the wrist that is not the one you specified with your profile's WRIST setting
  - 🔗 [Creating Your Profile](#)
- Walking for 20 seconds or less

## Viewing Life Log Data

Life Log lets you view the information below.

- Step count target value and daily target achievement rate
- Step count

## Viewing Life Log Data

### To view lifelog related data with the CASIO WATCHES phone app

You can use the CASIO WATCHES phone app to view data measured by the watch.

#### Check the connection

- Make sure the symbol is shown on the watch display when you perform the procedure below. If is not displayed, refer to the information at the link below.
  - [Connecting with a Phone Paired With the Watch](#)

1. Tap the "CASIO WATCHES" icon.
2. Tap the "My Page" tab.
3. Tap the "LIFE LOG" widget.
  - Open the LIFE LOG page and check the details.

#### Note

- You can also use the CASIO WATCHES phone app to specify a daily step target.
  - [Specifying a Daily Step Count Target](#)

### To view lifelog related data with the watch

1. Display the current time screen.
  - [Watch Mode](#)
2. Use (C) to select [LIFE LOG].



3. Press (A).
  - This displays the Life Log data summary screen.
4. Use (C) to select the screen you want to view.

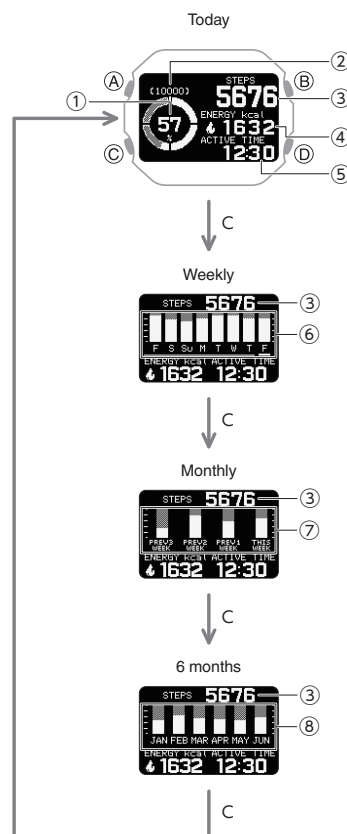

- ① Step count target achievement
  - ② Target value
  - ③ Today's step count
  - ④ Current day's burned calories
  - ⑤ Current day's active time
  - ⑥ Daily step count target achievement rate
  - ⑦ Weekly step count target achievement rate
  - ⑧ Monthly step count target achievement rate
5. Press (D) twice to return to the current time screen.

#### Note

- If you do not perform any operation for two or three minutes while the Life Log screen is displayed, the watch automatically returns to the current time screen.

#### Active Time

Your watch analyzes the measurement values of the acceleration sensor to determine whether you are walking, running, biking or performing another activity, or standing still. Your active time is the total time you spend walking, running, biking, or doing other activities during the day. When you are not measuring your heart rate, calorie consumption is also calculated based on behavior analysis.

## Almanac (Sunrise and Sunset Times, and Moon Age)

You can check the sunrise/sunset times and moon age for your manually specified Home City or for location information obtained by phone connection.

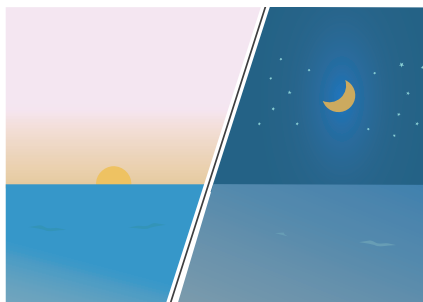

### Checking Sunrise and Sunset Times, and Moon Age

1. Display the current time screen.  
[Watch Mode](#)

2. Use (C) to select [ALMANAC].



3. Press (A).
4. Use (C) to select the day.  
 This displays the sunrise and sunset times, and the Moon age.



- ① Moon Graph + Moon Age  
[Interpreting the Moon Graph and Moon Age Indicator](#)
- ② Day
- ③ Sunrise time
- ④ Sunset time

#### Note

- Sunrise and sunset times are calculated internally by the watch. Calculation results may contain errors, with greater errors occurring at higher latitudes.
- [--:--] is displayed when calculation results cannot be output for some reason or in regions outside of 65.0° south to 65.0° north latitude.
- If you do not perform any operation for two or three minutes while the sunrise and sunset time screen is displayed, the watch automatically returns to the current time screen.

### Interpreting the Moon Graph and Moon Age Indicator

Moon phase	Moon age	This indicator:
New Moon	0.0 to 0.9	
	28.7 to 29.8	
	1.0 to 2.7	
	2.8 to 4.6	
First Quarter	4.7 to 6.4	
	6.5 to 8.3	
	8.4 to 10.1	
	10.2 to 12.0	
Full Moon	12.1 to 13.8	
	13.9 to 15.7	
	15.8 to 17.5	
	17.6 to 19.4	
Last Quarter	19.5 to 21.2	
	21.3 to 23.1	
	23.2 to 24.9	
	25.0 to 26.8	
	26.9 to 28.6	

- The indicators in the above table show approximate phase forms when facing south to look up at the Moon in the Northern Hemisphere. They are intended only to indicate whether the Moon's left or right side is darkened, and the Moon's actual appearance may be different. Also, in the Southern Hemisphere or near the equator, the Moon will appear in the northern sky, so the light and dark portions of the Moon will be opposite those shown by the watch's indicator.

## Time Adjustment

Your watch can connect with a phone to obtain information that it uses to correct its date and time setting.

### Important!

- Switch to Airplane Mode and use watch operations for time adjustment whenever you are inside an aircraft or any other area where phone use is prohibited or restricted.

- 🔗 [Entering the Watch Airplane Mode](#)
- 🔗 [Using Watch Operations to Adjust the Time Setting](#)

## Automatically Connecting with a Phone to Sync the Current Watch's Time Setting

### Auto Time Adjustment

Your watch can connect with your phone to adjust the watch's time setting.

If you leave your watch with the current time screen displayed, it will perform the adjustment operation automatically as you go about your daily life, without any operation required by you.

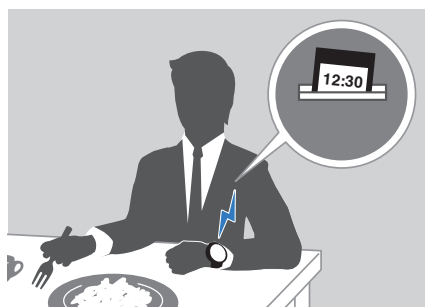

### Important!

- The watch may not be able to perform auto time correction under the conditions described below.
  - While the watch is too far away from its paired phone
  - While communication is not possible due to radio interference, etc.
  - While the phone is updating its system
  - While the CASIO WATCHES phone app is not running on the phone

### Note

- If there is a World Time City specified with the CASIO WATCHES phone app, its time will also be corrected automatically.
- Auto time correction is performed at the times described below.
  - After your phone's time zone or summer time setting is changed
  - After 24 hours or more have passed since the last time adjustment using Bluetooth connection
  - After 24 hours or more have passed since the last home city change or time adjustment using watch operation
- The watch remains connected with your phone even after time adjustment is complete.
- If time adjustment fails for some reason, [FAILED] will appear.
- Watch operation can be performed even while it is connected with your phone.
- Connection with your phone is not possible while the watch's Airplane Mode is enabled. To connect with your phone, disable the Airplane Mode.
  - 🔗 [Entering the Watch Airplane Mode](#)

## Manually Connecting with a Phone to Sync the Watch's Time Setting

You can use the procedure below to connect manually with a phone that is already paired with the watch.

1. Display the current time screen.
  - 🔗 [Watch Mode](#)
2. Hold down (C) for at least two seconds. This enters the Control Mode.
3. Use (C) to select [TIME ADJUSTMENT].



4. Press (A). This starts Bluetooth connection.
  - The acquired information appears on the watch display when time acquisition is successful.



- [FAILED] appears if acquisition fails.
5. Press any button and return to the TIME ADJUSTMENT screen.
  6. Press (D) to complete the setting operation.

## Using Watch Operations to Adjust the Time Setting

When your watch cannot communicate with your phone for some reason, you can use watch operations to adjust date and time settings.

### ● Setting a Home City

Use the procedure in this section to select a city to use as your Home City.

1. Display the current time screen.  
[Watch Mode](#)
2. Hold down (C) for at least two seconds.  
 This enters the Control Mode.
3. Use (C) to select [SETTING].



4. Press (A).  
 This displays the setting menu screen.

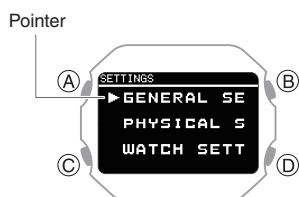

5. Use (C) to move the pointer to [WATCH SETTINGS].
6. Press (A).
7. Use (C) to move the pointer to [HOME TIME].
8. Press (A).

9. Use (C) to move the pointer to [HOME TIME CITY].
10. Press (A).
11. Use (C) to move the pointer to the city you want to use as your Home City.

12. Press (A) to complete the setting operation.

After the setting operation is complete, a check mark appears for a few seconds, and then the home time setting screen reappears.

13. Hold down (D) for at least one second to return to the current time screen.

### ● Configuring the Summer Time Setting

If you are in an area that observes summer time, you can also enable or disable summer time.

#### Note

- The initial factory default summer time setting for all cities is [AUTO]. In many cases, [AUTO] lets you use the watch without switching manually between summer time and standard time.

1. Display the current time screen.  
[Watch Mode](#)
2. Hold down (C) for at least two seconds.  
 This enters the Control Mode.
3. Use (C) to select [SETTING].



4. Press (A).  
 This displays the setting menu screen.

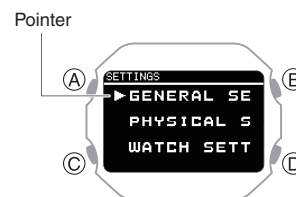

5. Use (C) to move the pointer to [WATCH SETTINGS].
6. Press (A).
7. Use (C) to move the pointer to [HOME TIME].
8. Press (A).
9. Use (C) to move the pointer to [DST].
10. Press (A).
11. Use (C) to select a summer time setting.

[AUTO]	Auto switching between standard time and summer time
[OFF]	Always standard time
[ON]	Always summer time

12. Press (A) to complete the setting operation.  
 After the setting operation is complete, a check mark appears for a few seconds, and then the home time setting screen reappears.
13. Hold down (D) for at least one second to return to the current time screen.

## ● To adjust the date manually

1. Display the current time screen.  
 Watch Mode
2. Hold down (C) for at least two seconds.  
 This enters the Control Mode.
3. Use (C) to select [SETTING].



4. Press (A).  
 This displays the setting menu screen.

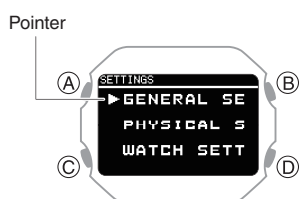

5. Use (C) to move the pointer to [WATCH SETTINGS].
6. Press (A).
7. Use (C) to move the pointer to [DATE & TIME].
8. Press (A).
9. Use (C) to move the pointer to [DATE SETTING].
10. Press (A).  
 This causes a cursor to appear under the year setting.
11. Use (C) to change the year setting.
12. Press (A).  
 This moves the cursor to the month setting.
13. Use (C) to change the month setting.

14. Press (A).  
 This moves the cursor to the day setting.
15. Use (C) to change the day setting.
16. Press (A) to complete the setting operation.  
 After the setting operation is complete, a check mark appears for a few seconds, and then the current time setting screen re-appears.
17. Hold down (D) for at least one second to return to the current time screen.

### Note

- Pressing (D) during the above procedure will go back one screen.

## ● To correct the time manually

1. Display the current time screen.  
 Watch Mode
2. Hold down (C) for at least two seconds.  
 This enters the Control Mode.
3. Use (C) to select [SETTING].



4. Press (A).  
 This displays the setting menu screen.

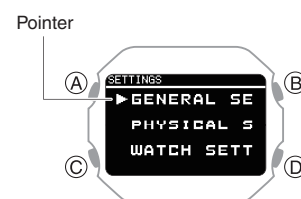

5. Use (C) to move the pointer to [WATCH SETTINGS].
6. Press (A).
7. Use (C) to move the pointer to [DATE & TIME].
8. Press (A).
9. Use (C) to move the pointer to [TIME SETTING].
10. Press (A).  
 This causes a cursor to appear under the hour setting.
11. Use (C) to change the hour setting.
12. Press (A).  
 This moves the cursor to the minute setting.
13. Use (C) to change the minute setting.
14. Press (A) to complete the setting operation.  
 After the setting operation is complete, a check mark appears for a few seconds, and then the current time setting screen re-appears.
15. Hold down (D) for at least one second to return to the current time screen.

## ● Switching between 12-hour and 24-hour Timekeeping

You can specify either 12-hour format or 24-hour format for the time display.

1. Display the current time screen.  
[Watch Mode](#)
2. Hold down (C) for at least two seconds.  
 This enters the Control Mode.
3. Use (C) to select [SETTING].



4. Press (A).  
 This displays the setting menu screen.

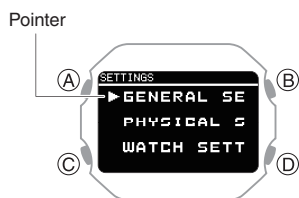

5. Use (C) to move the pointer to [WATCH SETTINGS].
6. Press (A).
7. Use (C) to move the pointer to [DATE & TIME].
8. Press (A).
9. Use (C) to move the pointer to [TIME FORMAT].
10. Press (A).
11. Use (C) to select [12H] (12-hour timekeeping) or [24H] (24-hour timekeeping).
12. Press (A) to complete the setting operation.  
 After the setting operation is complete, a check mark appears for a few seconds, and then the current time setting screen re-appears.
13. Hold down (D) for at least one second to return to the current time screen.
  - While 12-hour timekeeping is selected, [P] will be displayed for p.m. times.

## World Time

World Time lets you look up the current time in any one of 38 cities around the globe, and UTC (Coordinated Universal Time).



## Configuring World Time Settings

Perform the required operations with the CASIO WATCHES phone app or the watch to configure world time settings.

### ● To configure World Time settings with the CASIO WATCHES phone app

Specifying a World Time City with the CASIO WATCHES phone app causes the watch's World Time City to change accordingly. Settings can be configured to perform auto summer time switching for the World Time City.

#### Check the connection

- Make sure the  $\text{⌘}$  symbol is shown on the watch display when you perform the procedure below. If  $\text{⌘}$  is not displayed, refer to the information at the link below.  
[Connecting with a Phone Paired With the Watch](#)

#### Note

- The CASIO WATCHES phone app World Time lets you select from among approximately 300 cities as the World Time City.

### ● To select a World Time City

1. Tap the "CASIO WATCHES" icon.
2. Tap the "My Watch" tab.
3. Select "DW-H5600" and tap it.
4. Select the setting you want to change and then perform the operation shown on the screen.

#### Note

- You can use the CASIO WATCHES phone app to configure settings for user cities that are not included in the watch's built-in World Time Cities. You must use the CASIO WATCHES phone app to select a user city as your World Time City.

### ● Configuring the Summer Time Setting

1. Tap the "CASIO WATCHES" icon.
2. Tap the "My Watch" tab.
3. Select "DW-H5600" and tap it.
4. Select the setting you want to change and then perform the operation shown on the screen.
  - "AUTO"  
 The watch switches between standard time and summer time automatically.
  - "OFF"  
 The watch always indicates standard time.
  - "ON"  
 The watch always indicates summer time.

#### Note

- While the summer time setting is "AUTO", the watch switches between standard time and summer time automatically. You do not need to switch between standard time and summer time manually. Even if you are in an area that does not observe summer time, you can leave the watch's summer time setting as "AUTO".
- For information about summer time periods, refer to the "Summer Time Table".  
[Summer Time Table](#)

## ● Configuring World Time Settings with the Watch

Perform the required operations on the watch to select a World Time City and to configure summer time settings for your World Time City.

### ● To select a World Time City

1. Display the current time screen.  
[Watch Mode](#)
2. Use (C) to select [WORLD TIME].



3. Press (A).

This displays the current World Time City and the current time there.

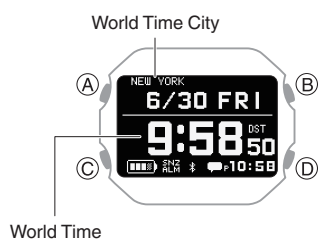

4. Hold down (C) for at least two seconds.

This displays the World Time setting screen.

- While the setting is being configured, the watch will exit the setting operation automatically after about two or three minutes of non-operation.

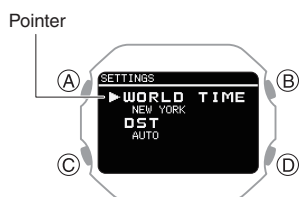

5. Use (C) to move the pointer to [WORLD TIME CITY].

6. Press (A).

This displays a menu of World Time Cities.



7. Use (C) to move the pointer to the city you want to use.

8. Press (A) to complete the setting operation.

After the setting operation is complete, a check mark appears for a few seconds, and then the World Time setting screen re-appears.

9. Press (D) to exit the setting screen.

This displays the current time and date in the selected city.



### Note

- If you select a World Time City with the CASIO WATCHES phone app and then change to a different city with a watch operation, the CASIO WATCHES city information is deleted from the watch.

[To configure World Time settings with the CASIO WATCHES phone app](#)

## ● Configuring Summer Time Settings

1. Display the current time screen.

[Watch Mode](#)

2. Use (C) to select [WORLD TIME].



3. Press (A).

This displays the current World Time City and the current time there.

4. Hold down (C) for at least two seconds.

This displays the World Time setting screen.

- While the setting is being configured, the watch will exit the setting operation automatically after about two or three minutes of non-operation.

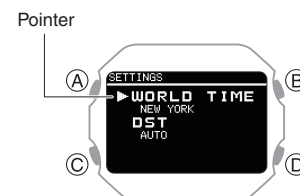

5. Use (C) to move the pointer to [DST].

6. Press (A).

7. Use (C) to select a summer time setting.

[AUTO]	The watch switches between standard time and summer time automatically.
[OFF]	The watch always indicates standard time.
[ON]	The watch always indicates summer time.

8. Press (A) to complete the setting operation.

After the setting operation is complete, a check mark appears for a few seconds, and then the World Time setting screen re-appears.

9. Press (D) to exit the setting screen.

### Note

- The initial factory default summer time setting for all cities is [AUTO]. In many cases, [AUTO] lets you use the watch without switching manually between summer time and standard time.
- While [UTC] is selected as the city, you will not be able to change or check the summer time setting.

## Alarm

The watch performs a beep or vibration alert operation when an alarm time is reached. You can set up to four different alarms. The hourly time signal causes the watch to beep every hour on the hour.

- You can enable the beep and vibration alerts as required.
  - [Configuring Sound and Vibration Settings](#)
- The watch does not perform a vibration alert while the battery level indicator shows **LDW**. The watch does not perform a beep alert while the battery level indicator is "CHG" or lower.
- While the snooze function is turned on, the alert operation is performed up to seven times every five minutes.
- For information about a smart alarm that detects your sleep status and alerts you when your sleep is light, see the information below.
  - [Smart Alarm](#)

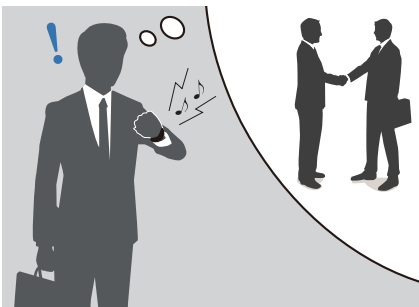

## Configuring Alarm Settings

Use the CASIO WATCHES phone app or watch operations to configure alarm settings.

### To configure alarm settings with the CASIO WATCHES phone app

#### Check the connection

- Make sure the  $\text{✂}$  symbol is shown on the watch display when you perform the procedure below. If  $\text{✂}$  is not displayed, refer to the information at the link below.
  - [Connecting with a Phone Paired With the Watch](#)

- Tap the "CASIO WATCHES" icon.
- Tap the "My Watch" tab.
- Select "DW-H5600" and tap it.
- Select the setting you want to change and then perform the operation shown on the screen.

### To configure alarm settings with the watch

- Display the current time screen.
  - [Watch Mode](#)
- Hold down (C) for at least two seconds. This enters the Control Mode.
- Use (C) to select [SETTING].



- Press (A). This displays the setting menu screen.

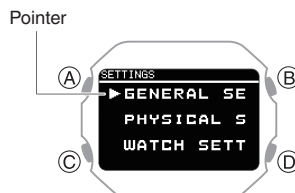

- Use (C) to move the pointer to [WATCH SETTINGS].
- Press (A). This displays the watch setting screen.
- Use (C) to move the pointer to [ALARM].
- Press (A).
- Use (C) to move the pointer to the alarm you want to set.



- Press (A).
- Use (C) to select an alarm and snooze function ON/OFF setting.

[OFF]	Disables alarm, disables snooze
[ON]	Enables alarm, disables snooze
[ON (SNZ)]	Enables alarm, enables snooze

- The currently selected setting will be indicated by a check mark (✓) to the left.

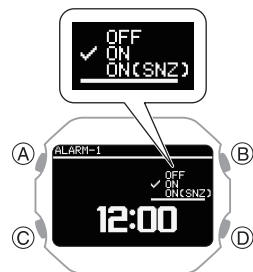

- Press (A).
- Use (C) to set the alarm hour.

14. Press (A).
15. Use (C) to set the alarm minute.
16. Press (A) to complete the setting operation.

After the setting operation is complete, a check mark appears for a few seconds, and then the alarm selection screen reappears.

- You can view the setting time of the alarm and whether the alarm setting and snooze setting are on or off.

17. Hold down (D) for at least one second to return to the current time screen.

### Note

- If you want to exit the alarm setting operation at any time, press (D) several times to return to the watch setting screen.

### ● To stop a sounding alarm

While an alarm sound and/or vibration operation is being performed, press any button to stop it.

### Note

- The watch performs a 10-second sound/vibration operation when a preset alarm time is reached.
- When snooze is enabled for an alarm, alarm sound and/or vibration will repeat every five minutes, up to seven times. To stop an alarm's ongoing snooze operation, turn off the alarm.
- If you do not perform any operation for two or three minutes while the setting screen is displayed, the watch automatically returns to the current time screen.

## Enabling the Hourly Time Signal

Use the CASIO WATCHES phone app to turn the hourly time signal on or off.

### Important!

- You cannot change the hourly time signal setting using a watch operation. Use the CASIO WATCHES phone app to change the setting.

### Note

- You may need to update your watch software to use the hourly time signal. [Updating the Watch's Software Version](#)

### Check the connection

- Make sure the symbol is shown on the watch display when you perform the procedure below. If is not displayed, refer to the information at the link below. [Connecting with a Phone Paired With the Watch](#)

1. Tap the "CASIO WATCHES" icon.
2. Tap the "My Watch" tab.
3. Select "DW-H5600" and tap it.
4. Select the setting you want to change and then perform the operation shown on the screen.

### Note

- The hourly time signal is disabled during the period you have set as NIGHT TIME.

## Turning Off an Alarm

To stop an alarm sound and/or vibration operation, perform the steps below to turn it off.

- To reactivate an alarm sound and/or vibration operation, turn it back on.

### Note

- An indicators is displayed while any one of the alarms is turned on.
- The alarm indicator is not displayed while all of the alarms are turned off.



1. Display the current time screen. [Watch Mode](#)
2. Hold down (C) for at least two seconds. This enters the Control Mode.
3. Use (C) to select [SETTING].



4. Press (A). This displays the setting menu screen.

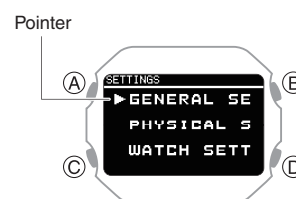

5. Use (C) to move the pointer to [WATCH SETTINGS].
6. Press (A). This displays the watch setting screen.
7. Use (C) to move the pointer to [ALARM].

8. Press (A).
9. Use (C) to move the pointer to the alarm you want to turn off.



10. Press (A).
11. Use (C) to select [OFF].
12. Press (A) to complete the setting operation.

After the setting operation is complete, a check mark appears for a few seconds, and then the alarm selection screen reappears.

13. Hold down (D) for at least one second to return to the current time screen.
  - Turning off all alarms causes [ALM] (alarm) to disappear from the display.



### Note

- If [ALM] (alarm) is still displayed after you turn off an alarm, it means at least one of the other alarms is still turned on. To turn off all alarms, repeat steps 8 through 11 until the [ALM] (alarm) indicator is no longer displayed.
- If [ALM] (alarm) is still displayed even after you turn off all the alarms, it means the smart alarm is turned on. Turn off the smart alarm.  
[Turning Off Smart Alarm](#)

## Stopwatch

The stopwatch can be used to perform 1-second unit elapsed time measurement up to 99 hours, 59 minutes, 59 seconds.

It can also measure split times.



## Measuring Elapsed Time

1. Display the current time screen.  
[Watch Mode](#)
2. Use (C) to select [STOPWATCH].



3. Press (A).  
 This displays the stopwatch screen.
4. Use the operations below to measure elapsed time.

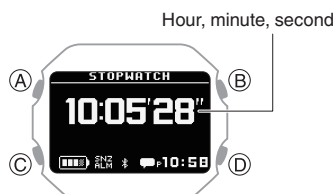
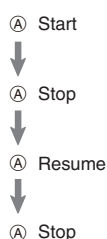

5. Press (D) to reset the stopwatch to all zeros.

## Measuring a Split Time

1. Display the current time screen.  
[Watch Mode](#)
2. Use (C) to select [STOPWATCH].



3. Press (A).  
 This displays the stopwatch screen.
4. Use the operations below to measure elapsed time.

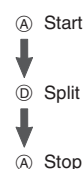

5. Press (D) to reset the stopwatch to all zeros.

## Timer

The timer counts down from a start time specified by you. The watch performs a sound and/or vibration operation when the end of the countdown is reached.

- The watch does not perform a vibration alert while the battery level indicator shows **LOW**. The watch does not perform a beep alert while the battery level indicator is "CHG" or lower.

- You can enable the beep and vibration alerts as required.

[Configuring Sound and Vibration Settings](#)



### Setting a Start Time

The start time can be set in 1-second units up to 60 minutes.

#### ● To configure timer settings with the CASIO WATCHES phone app

If the watch is paired with a phone, you can also use the CASIO WATCHES phone app to set the timer start time.

[Configuring Watch Settings](#)

#### ● To configure timer settings with the watch

##### EZ Settings

Use this procedure to change the timer start time setting in 30-second increments.

1. Display the current time screen.  
[Watch Mode](#)

2. Use (C) to select [TIMER].



3. Press (A).

This displays the TIMER screen.

4. Press (C).

This returns to the EZ setting screen.



5. Use (C) to configure the timer setting.

- Each press of (C) changes the value by +30 seconds.

6. Press (A).

This starts the timer operation.

##### Minute and Seconds Setting

You can use the steps below to change the timer start time setting in one-second increments up to 60 minutes.

1. Display the current time screen.  
[Watch Mode](#)
2. Use (C) to select [TIMER].



3. Press (A).

This displays the TIMER screen.

4. Hold down (C) for at least two seconds.

This causes a cursor to appear under the minutes setting.

5. Use (C) to change the timer minutes setting.

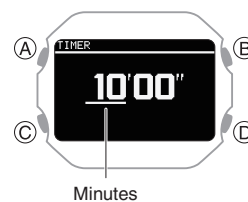

6. Press (A).

This moves the cursor to the seconds setting.

7. Use (C) to change the timer seconds setting.

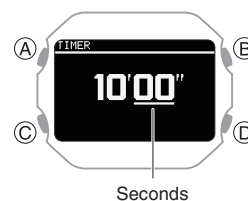

- To return to the minute setting, press (D).

8. Press (A) to complete the setting operation.

After the setting operation is complete, a check mark appears for a few seconds, and then the TIMER screen re-appears.

## Note

- To exit the timer setting operation at any point, press (D).
- While the setting is being configured, the watch will exit the setting operation automatically after about two or three minutes of non-operation.

## Using the Timer

1. Display the current time screen.  
[Watch Mode](#)

2. Use (C) to select [TIMER].



3. Press (A).  
 This displays the TIMER screen.

4. Use the operations below to perform a timer operation.

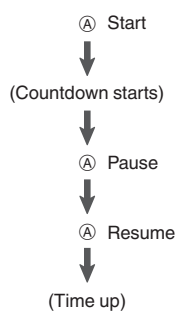

- The watch performs a sound and/or vibration operation for 10 seconds when the end of the countdown is reached.
  - You can reset a paused countdown to its start time, by pressing (D).
5. Press any button to stop the sound and/or vibration operation.

## Receiving Phone Notifications

You can use your watch to check the details of incoming calls, mail, and SNS alerts and information that are received by a phone connected to the watch by Bluetooth. The watch can have up to 10 notifications stored in its memory.

- To receive notifications from your phone, you need to pair the watch with it.

[Pairing the Watch with Your Phone](#)

You can check for new notifications on the current time screen and in the Activity Mode.

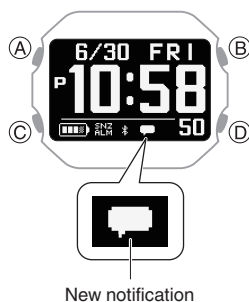

With the notification list, you can check the notification type, and the date and time the notification was received.

This indicator:	Means this:
	Mail
	SNS
	Incoming calls, missed calls
	Schedule
	Other

- The message [NO DATA] will appear if there are no new messages.
- While notification receive is enabled, reception of a notification causes its contents to appear on the display, regardless of the mode (Notification Cut-in).

[Enabling and Disabling Incoming Call Notifications](#)

- The watch performs a sound and/or vibration operation when a notification is received. You can enable or disable sound and vibration alert as required.

[Configuring Sound and Vibration Settings](#)

- The sound/vibration operation for incoming phone call notifications lasts up to 20 seconds, while all other notifications last one second.

## Important!

- To receive phone notifications, configure the settings below on your phone.

iPhone: Configure all of the settings below.

- Enable CASIO WATCHES phone app notifications.
- Turn on "Settings" → "Bluetooth" → "CASIO DW-H5600" → "Share System Notifications".
- Allow notifications for each app you want to be notified about, and make sure all of the following boxes are checked (selected): Notifications Lock Screen, Notification Center, Banners.

Example: Mail app: "Settings" → "Mail" → "Notifications"

Android: Enable all the items below.

- Notification access
- Contacts access
- Call history access
- After the notification cut-in is displayed for 1 minute, the display returns to the screen that was shown before the cut-in appeared. While a notification cut-in is displayed, press (C) to check the notification content.
- Notifications are not received while any one of the screens below is displayed.
  - Breathing exercise preparation screen
  - Breathing exercise measurement screen
  - Target step count achievement screen

## Enabling and Disabling Incoming Call Notifications

You can enable or disable notification receive as required.

1. Display the current time screen.  
 Watch Mode
2. Hold down (C) for at least two seconds.  
 This enters the Control Mode.
3. Use (C) to select [SETTING].



4. Press (A).  
 This displays the setting menu screen.

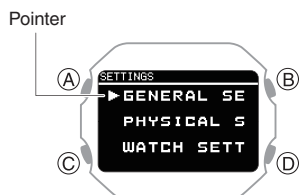

5. Use (C) to move the pointer to [GENERAL SETTINGS].
6. Press (A).
7. Use (C) to move the pointer to [NOTIFICATIONS].
8. Press (A).

9. Use (C) to select a notification receive ON/OFF setting.

[OFF]	Notifications are turned off, and notification cut-ins do not appear.
[ACTIVITY OFF]	Notification receive is turned off during activity measurement only.
[NIGHT TIME OFF]	Notification receive is turned off during the specified night time.
[ACTIVITY & NIGHT TIME OFF]	Notification receive is turned off during activity measurement and the specified night time.
[ON]	Enables receive and notification cut-in display.

- Notification cut-ins display the details of a received notification.
- After about one minute, the watch returns to the screen that was shown before the notification cut-in appeared.

10. Press (A) to complete the setting operation.

After the setting operation is complete, a check mark appears for a few seconds, and then the GENERAL SETTINGS screen re-appears.

11. Hold down (D) for at least one second to return to the current time screen.

### Note

- If you do not perform any operation for two or three minutes while the setting screen is displayed, the watch automatically returns to the current time screen.

## Displaying Notification Contents

1. Display the current time screen.  
 Watch Mode
2. Use (C) to select [NOTIFICATION].



3. Press (A).

This displays the notification list.

- The notification list can contain up to 10 notifications.
  - Addition of a notification to the list when it already contains 10 notifications, will cause the oldest notification in the list to be deleted to make room for the new one.
4. Use (C) to move the pointer to the title of the notification you want to view.
  5. Press (A).  
 This displays the details of the notification.
    - You can use (C) to scroll.
    - To return to the notification list, press (D).
    - To return to the current time screen, hold down (D) for at least one second.

## Cycling Between Notification Cut-in Displays

You can use this procedure to specify either simple display or full display of notification cut-in.

1. Display the current time screen.  
 Watch Mode
2. Hold down (C) for at least two seconds.  
 This enters the Control Mode.
3. Use (C) to select [SETTING].



4. Press (A).  
 This displays the setting menu screen.

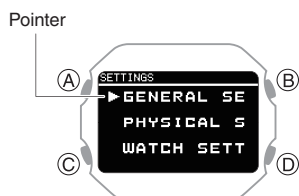

5. Use (C) to move the pointer to [GENERAL SETTINGS].
6. Press (A).  
 This displays the GENERAL SETTINGS screen.



7. Use (C) to move the pointer to [NOTIFICATION PATTERN].
8. Press (A).

9. Use (C) to change the display type setting.

[SIMPLE]	Simple display
[FULL]	Full display

10. Press (A) to complete the setting operation.  
 After the setting operation is complete, a check mark appears for a few seconds, and then the GENERAL SETTINGS screen re-appears.
11. Hold down (D) for at least one second to return to the current time screen.

### Note

- If you do not perform any operation for two or three minutes while the setting screen is displayed, the watch automatically returns to the current time screen.

## Deleting a Notification

### Deleting a Particular Notification

1. Display the current time screen.  
 Watch Mode
2. Use (C) to select [NOTIFICATION].



3. Press (A).  
 This displays the notification list.
4. Use (C) to move the pointer to the title of the notification you want to delete.
5. Press (A).  
 This displays the details of the notification.
6. Hold down (C) for at least two seconds.  
 This displays the data delete screen.

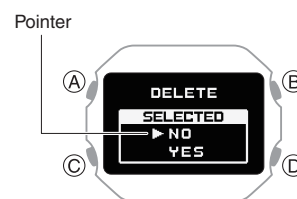

7. Use (C) to move the pointer to [YES].
  - To cancel data deletion, move the pointer to [NO].
8. Press (A).  
 After the data delete operation is complete, a check mark appears for a few seconds, and then the notification list screen re-appears.

## Deleting All Notifications

1. Display the current time screen.  
 Watch Mode
2. Use (C) to select [NOTIFICATION].



3. Press (A).  
This displays the notification list.
4. Hold down (C) for at least two seconds.  
This displays the data delete screen.

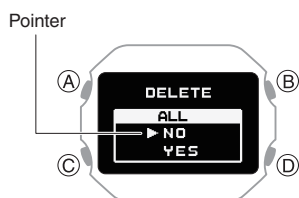

5. Use (C) to move the pointer to [YES].
  - To cancel data deletion, move the pointer to [NO].
6. Press (A).  
After the data delete operation is complete, a check mark appears for a few seconds, and then [NO DATA] appears.

## Activity Measurement Settings

This section explains how to configure settings related to activity measurement. The setting menu that is displayed depends on the activity.

### Activity-specific Setting Menu

Activity	Setting Menu
GYM WORKOUT	TRAINING ALERT
INTERVAL TIMER	TRAINING ALERT INTERVAL TIMER
RUNNING	AUTO LAP
WALKING	AUTO PAUSE TRAINING ALERT

## Enabling Auto Lap Timing

While auto lap timing is enabled, a lap is recorded each time you run the lap distance you specified.

Perform the required operations with the CASIO WATCHES phone app or on the watch to configure auto lap measurement settings.

You can set a lap measurement distance up to 10.0 km, in increments of 0.1 km.

### To configure auto lap settings with the CASIO WATCHES phone app

Before using Auto Lap Timing, you need to use the CASIO WATCHES phone app to specify the Auto Lap Timing distance.

#### Check the connection

- Make sure the symbol is shown on the watch display when you perform the procedure below. If is not displayed, refer to the information at the link below.

[Connecting with a Phone Paired With the Watch](#)

1. Tap the "CASIO WATCHES" icon.
2. Tap the "My Watch" tab.
3. Select "DW-H5600" and tap it.
4. Select the setting you want to change and then perform the operation shown on the screen.

### To configure auto lap settings with the watch

1. Display the current time screen.  
 Watch Mode
2. Press (A).  
This enters the Activity Mode.

#### Example:



3. Use (C) to select an activity.
4. Press (A).  
This displays the measurement operation ready screen.
5. Hold down (C) for at least two seconds.  
This displays the activity measurement setting screen.

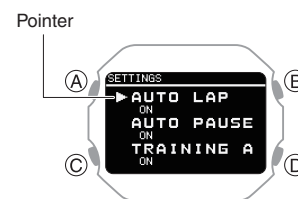

6. Use (C) to move the pointer to [AUTO LAP].
7. Press (A).
8. Use (C) to select [ON].
  - To disable auto lap measurement, select [OFF].
  - The currently selected setting will be indicated by a check mark () to the left.
9. Press (A).  
This causes a cursor to appear, which you can use to set the auto lap measurement distance.

- Use (C) to specify the integer part of the distance value.



- Press (A).

This moves the cursor to the decimal part of the distance value.

- Use (C) to specify the decimal part of the distance value.



- Press (A) to complete the setting operation.

After the setting operation is complete, a check mark appears for a few seconds, and then the activity measurement setting screen re-appears.

- Press (D) to exit the setting screen.

### Note

- While the setting is being configured, the watch will exit the setting operation automatically after about two or three minutes of non-operation.

## Enabling Auto Pause

While Auto Pause is enabled, timing will pause whenever you stop running.

### Note

- When a measurement operation is restarted from auto pause, the watch display will be delayed from the actual start, but the time and distance being measured are not affected.
- If auto pause does not work after it is enabled or if measurement does not resume, pause and resume measurement manually.

- Display the current time screen.

Watch Mode

- Press (A).

This enters the Activity Mode.

### Example:



- Use (C) to select an activity.

- Press (A).

This displays the measurement operation ready screen.

- Hold down (C) for at least two seconds.

This displays the activity measurement setting screen.

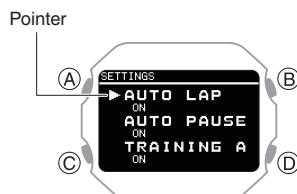

- Use (C) to move the pointer to [AUTO PAUSE].

- Press (A).

- Use (C) to move the pointer to [ON] (enabled) or [OFF] (disabled).

- Press (A) to complete the setting operation.

After the setting operation is complete, a check mark appears for a few seconds, and then the activity measurement setting screen re-appears.

- Press (D) to exit the setting screen.

### Note

- While the setting is being configured, the watch will exit the setting operation automatically after about two or three minutes of non-operation.
- You can also use the CASIO WATCHES phone app to enable or disable Auto Pause.

## Configuring Training Alert Settings

You can use the CASIO WATCHES phone app to specify target alert intervals to inform you of your calories burned, elapsed time, and distance traveled during training. Every time an alert target value is reached during activity measurement, a sound or vibration operation is performed, and an alert screen appears to notify you.

You can use a single watch operation to toggle all the alerts you configured with the CASIO WATCHES phone app between on and off.

### ● To specify training alert target values with the CASIO WATCHES phone app

#### Important!

- Note that you cannot specify alert target values using watch operations. Use the CASIO WATCHES phone app to configure settings.

#### Check the connection

- Make sure the symbol is shown on the watch display when you perform the procedure below. If is not displayed, refer to the information at the link below.

[Connecting with a Phone Paired With the Watch](#)

1. Tap the "CASIO WATCHES" icon.
2. Tap the "My Watch" tab.
3. Select "DW-H5600" and tap it.
4. Select the setting you want to change and then perform the operation shown on the screen.

### ● To enable training alert with the watch

1. Display the current time screen.

[Watch Mode](#)

2. Press (A).

This enters the Activity Mode.

**Example:**



3. Use (C) to select an activity.

4. Press (A).

This displays the measurement operation ready screen.

5. Hold down (C) for at least two seconds.

This displays the activity measurement setting screen.

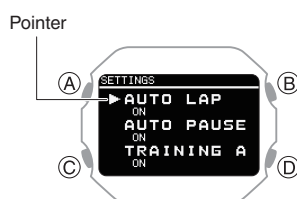

6. Use (C) to move the pointer to [TRAINING ALERT].

7. Press (A).

8. Use (C) to move the pointer to [ON].

- If you want to disable training alerts, move the pointer to [OFF].

9. Press (A) to complete the setting operation.

After the setting operation is complete, a check mark appears for a few seconds, and then the activity measurement setting screen re-appears.

10. Press (D) to exit the setting screen.

#### Important!

- Use the CASIO WATCHES phone app to specify an alert target value for each item. You cannot use watch operations to configure alert target value settings.

#### Note

- While the setting is being configured, the watch will exit the setting operation automatically after about two or three minutes of non-operation.

## Training Alert Screen Indicators

A training alert screen appears on the watch when a specified target value is reached during activity measurement.

Indicator:	Meaning:
	Calories burned target value reached.
	Elapsed time target value reached.
	Travel distance target value reached.

### Note

- Alerts that can be configured depend on the activity.

## Alert Screen Switching

A training alert screen appears when a specified target value is reached during activity measurement.

### Example:



- The watch returns to the running measurement screen if you press (A) or if you do not perform any operation for about nine seconds.

## Configuring Interval Timer Settings

### To configure interval timer settings with the CASIO WATCHES phone app

You can use the CASIO WATCHES phone app to configure an interval timer that combines multiple types of timers.

- For information about interval timers, see the information below.

[Overview](#)

### Check the connection

- Make sure the  $\text{⌘}$  symbol is shown on the watch display when you perform the procedure below. If  $\text{⌘}$  is not displayed, refer to the information at the link below.

[Connecting with a Phone Paired With the Watch](#)

- Tap the "CASIO WATCHES" icon.
- Tap the "My Watch" tab.
- Select "DW-H5600" and tap it.
- Select the setting you want to change and then perform the operation shown on the screen.

### To configure interval timer settings with the watch

- If a timer countdown operation is in progress, reset the timer to its current start time before performing this operation.

[Using the Timer](#)

- Display the current time screen.
- Press (A).  
This enters the Activity Mode.
- Use (C) to select [INTERVAL TIMER].



- Press (A).

- Hold down (C) for at least two seconds.  
This displays the interval training setting screen.

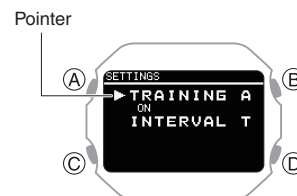

- Use (C) to move the pointer to [INTERVAL TIMER].

- Press (A).

This displays the interval timer setting screen.



- Use (C) to move the pointer to [REPEAT].

- Press (A).

This displays the number of timer repeats (1 to 10) setting screen.

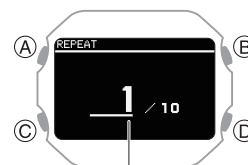

Number of repeats

- Use (C) to specify the number of timer repeats (Auto Repeat).

- Press (A).

After the setting operation is complete, a check mark appears for a few seconds, and then the interval timer setting screen re-appears.

- Use (C) to specify the sequence of the timers.

- To setup the first timer, setup [TIMER1].

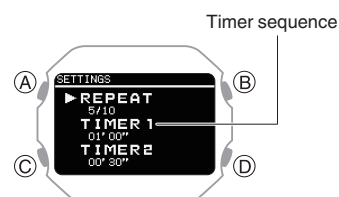

13. Press (A).

This causes the cursor to appear at the minutes setting of the first timer.

14. Use (C) to change the timer minutes setting.

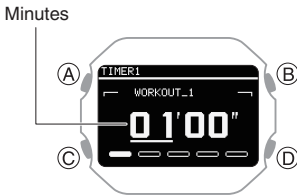

15. Press (A).

This causes the cursor to move to the seconds setting of the first timer.

16. Use (C) to change the timer seconds setting.

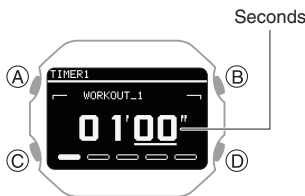

17. Press (A) to complete the setting operation.

After the setting operation is complete, a check mark appears for a few seconds, and then the interval timer setting screen re-appears.

18. Repeat steps 11 through 16 as many times as necessary to configure the settings of other timers.

### Note

- Pressing (D) during the above procedure goes back one screen.
- You can use the CASIO WATCHES phone app to change timer names. A timer name can include a combination of up to 14 alphabetic letters (A to Z), numbers (0 to 9), and symbols (/+\_-? &).

## Using the Application to Configure Settings

This section explains the main watch settings that can be changed only with the "CASIO WATCHES" phone app.

To use the settings in this section, you need to install the "CASIO WATCHES" phone app on your phone.

📍 ① Install the required app on your phone.

## Specifying a Watch Face

There are three watch face patterns that you can use for the current time screen. You can select the pattern that suits your current lifestyle.

You can customize the display items for Face 2.

### Important!

- You cannot use watch operations to customize the Face 2 display items. Use the CASIO WATCHES phone app to configure settings.
- You can use watch operations to select a watch face.

📍 Changing the Watch Face

### Face 1



### Face 2



You can select from among the display items below when customizing the Face 2 display.

### Text-Plus-Value Items

[STEPS]	Today's step count
[STATUS]	Cardio Load Status (Cardio Load Status)
[DISTANCE]	Monthly running distance • RUN • WALK
[HR]	Heart rate
[MAX MIN]	Maximum/Minimum heart rate
[SLEEP]	• Sleep score + level display • Sleep time • Sleep evaluation
[CALORIES]	Calories burned
[ACTIVE]	Current day's physical exercise time
Sunrise and sunset times	
Moon age	

### Face 3

Step count target achievement graph \*



\* This graph shows the step count target achievement rate for the past eight days, including today.

## Configuring Settings

Use the CASIO WATCHES phone app to specify which current time screen you want to display. In the case of the customizable display, you can specify the items you want to include on the display.

### Important!

- You cannot use watch operations to customize the Face 2 display items. Use the CASIO WATCHES phone app to configure settings.

### Check the connection

- Make sure the symbol is shown on the watch display when you perform the procedure below. If is not displayed, refer to the information at the link below.

[Connecting with a Phone Paired With the Watch](#)

- Tap the "CASIO WATCHES" icon.
- Tap the "My Watch" tab.
- Select "DW-H5600" and tap it.
- Select the setting you want to change and then perform the operation shown on the screen.

## Customizing the Watch Mode and Activity Mode Functions

You can use the CASIO WATCHES phone app to specify the sequence that functions appear in the Watch Mode and Activity Mode. You can also add or delete functions as desired.

### Important!

- You cannot perform function customization operations on the watch. Use the CASIO WATCHES phone app to configure settings.

For information about functions that can be rearranged and deleted, see the information below.

- [Watch Mode](#)
- [Activity Overview](#)

### Check the connection

- Make sure the symbol is shown on the watch display when you perform the procedure below. If is not displayed, refer to the information at the link below.

[Connecting with a Phone Paired With the Watch](#)

- Tap the "CASIO WATCHES" icon.
- Tap the "My Watch" tab.
- Select "DW-H5600" and tap it.
- Select the setting you want to change and then perform the operation shown on the screen.

### Note

- Adding or deleting functions may change settings.
- Even if you remove the almanac (sunrise, sunset times, Moon age) function, you can still display the sunrise and sunset times on the current time screen.

## Configuring Activity Measurement Display Settings

There are various types of activity measurement screens, and up to 7 screens can be registered for each activity.

From among the registered screens, you can specify which one should be displayed while each activity measurement is in progress.

### Important!

- You can specify activity measurement screens using the CASIO WATCHES phone app. You cannot use watch operations to configure activity measurement screen settings.

- Screen 1 is fixed as "Measurement Screen 1". Select screens 2 to 7 from among screens that are other than "Measurement Screen 1".

### Measurement Screen 1



From among the following, select the screens to be displayed for screens 2 through 7.

### Measurement Screen 2



### Measurement Screen 3

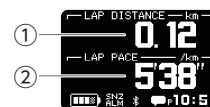

- You can customize the items that appear in the ① upper and ② lower sections of the measurement screen 1 to 3. You can also use the CASIO WATCHES phone app to customize items with your phone.

## Heart Rate Measurement Screen



- ① Target HR zone value
- ② Current heart rate

## Current time screen



- ① Current time
- ② Movement time from measurement start

## Almanac screen



- ① Date of measurement
- ② Measurement day Moon age
- ③ Measurement day sunrise time
- ④ Measurement day sunset time
- ⑤ Movement time from measurement start

## Interval timer screen



- ① Interval timer value
- ② Number of repeats
- ③ Total measurement time

### Note

- In the case of INTERVAL TIMER, Screen 1 shows the interval timer screen.

## Configuring Settings

### Check the connection

- Make sure the symbol is shown on the watch display when you perform the procedure below. If is not displayed, refer to the information at the link below.
  - [Connecting with a Phone Paired With the Watch](#)

1. Tap the “CASIO WATCHES” icon.
2. Tap the “My Watch” tab.
3. Select “DW-H5600” and tap it.
4. Select the setting you want to change and then perform the operation shown on the screen.

## Using Your Phone’s GPS

When performing a RUNNING/WALKING measurement, your phone’s GPS can be used to correct the distance calculated by the watch’s built-in acceleration sensor. This improves the accuracy of distance calculations.

You can use the CASIO WATCHES phone app to enable or disable use of your phone’s GPS.

### Check the connection

- Make sure the symbol is shown on the watch display when you perform the procedure below. If is not displayed, refer to the information at the link below.
  - [Connecting with a Phone Paired With the Watch](#)

1. Tap the “CASIO WATCHES” icon.
2. Tap the “My Watch” tab.
3. Select “DW-H5600” and tap it.
4. Select the setting you want to change and then perform the operation shown on the screen.

## Enabling the Wrist Sensor

You can use the CASIO WATCHES phone app to enable or disable the wrist sensor so the watch can detect whether or not it is attached to your wrist.

- The wrist sensor is enabled under initial factory default settings.

### Important!

- You cannot change the wrist sensor setting using watch operations. Use the CASIO WATCHES phone app to configure settings.

### Check the connection

- Make sure the symbol is shown on the watch display when you perform the procedure below. If is not displayed, refer to the information at the link below. [Connecting with a Phone Paired With the Watch](#)

1. Tap the "CASIO WATCHES" icon.
2. Tap the "My Watch" tab.
3. Select "DW-H5600" and tap it.
4. Tap "Watch Settings".
5. Tap "Find Worn Watch".
6. Enable "On".

## Specifying Your Desired Bedtime and Wake-Up Time

You can use the CASIO WATCHES phone app to specify your bedtime and wake-up time.

### Important!

- You cannot use watch operations to configure bedtime and wake-up time settings. Use the CASIO WATCHES phone app to configure settings.

### Check the connection

- Make sure the symbol is shown on the watch display when you perform the procedure below. If is not displayed, refer to the information at the link below. [Connecting with a Phone Paired With the Watch](#)

1. Tap the "CASIO WATCHES" icon.
2. Tap the "My Watch" tab.
3. Select "DW-H5600" and tap it.
4. Tap "LIFE LOG".
5. Tap "Sleep".
6. Configure "Sleeping Time" and "Waking Time" settings.

## Specifying a Daily Step Count Target

You can use CASIO WATCHES to specify daily step count target values.

### Important!

- A target value cannot be specified using watch operations. Use the CASIO WATCHES phone app to configure settings.

### Check the connection

- Make sure the symbol is shown on the watch display when you perform the procedure below. If is not displayed, refer to the information at the link below. [Connecting with a Phone Paired With the Watch](#)

1. Tap the "CASIO WATCHES" icon.
2. In the upper right corner of the screen, tap .
3. Tap "User Profile".
4. Select the setting you want to change and then perform the operation shown on the screen.

### Note

- In addition to target values, you can also configure settings to alert you when a target is reached.

## Configuring Watch Settings

After establishing a connection between the watch and the CASIO WATCHES phone app, you can use the phone app to configure various watch function settings and to view information acquired by the watch.

### Check the connection

- Make sure the symbol is shown on the watch display when you perform the procedure below. If is not displayed, refer to the information at the link below.

[Connecting with a Phone Paired With the Watch](#)

1. Tap the “CASIO WATCHES” icon.
2. Tap the “My Watch” tab.
3. Select “DW-H5600” and tap it.
4. Select the setting you want to change and then perform the operation shown on the screen.

## Other Settings

This section explains other watch settings you can configure.

### Changing the Watch Face

There are three watch face patterns that you can use for the current time screen. You can select the pattern that suits your current lifestyle.

For details about the three watch faces, refer to the information at the link.

[Specifying a Watch Face](#)

1. Display the current time screen.  
[Watch Mode](#)
2. Hold down (C) for at least two seconds.  
This enters the Control Mode.
3. Use (C) to select [SETTING].



4. Press (A).  
This displays the setting menu screen.

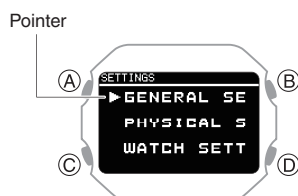

5. Use (C) to move the pointer to [WATCH SETTINGS].
6. Press (A).
7. Use (C) to move the pointer to [WATCH FACE].
8. Press (A).
9. Use (C) to move the pointer to the watch face you want to select.



- For details about displaying and customizing each watch face, see the information below.  
[Specifying a Watch Face](#)

10. Press (A) to complete the setting operation.

After the setting operation is complete, a check mark appears for a few seconds, and then the watch face setting screen reappears.

11. Hold down (D) for at least one second to return to the current time screen.

### Turning On Silent Mode

While the silent mode is turned on, the watch only vibrates for notifications regardless of the beep and vibration notification settings.

Illumination will not turn on while a notification or button operation is in progress.

#### Note

- You may need to update your watch software to use silent mode.  
[Updating the Watch's Software Version](#)

1. Display the current time screen.  
[Watch Mode](#)
2. Hold down (D) for at least three seconds to toggle silent mode on or off.
  - Turning on silent mode causes to appear on the display.

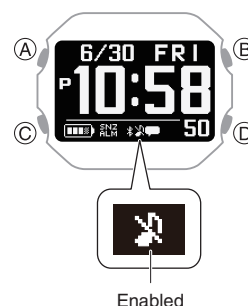

#### Note

- If the beeper alert and vibration are turned off and silent mode is turned on, beeper, vibration, and light notification operations are not performed.

## Enabling Step Reminder

Step Reminder displays an indicator and performs a sound or vibration alert when the watch determines you have not walked enough during a specific period. This is valuable feedback that helps you achieve your exercise goals.

If the watch performs this Step Reminder alert operation, try walking for about five minutes.

1. Display the current time screen.  
🔍 Watch Mode
2. Hold down (C) for at least two seconds.  
 This enters the Control Mode.
3. Use (C) to select [SETTING].



4. Press (A).  
 This displays the setting menu screen.

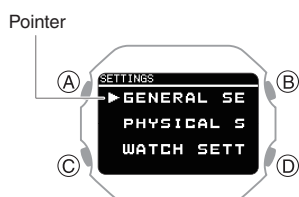

5. Use (C) to move the pointer to [GENERAL SETTINGS].
6. Press (A).  
 This displays the GENERAL SETTINGS screen.



7. Use (C) to move the pointer to [STEP REMINDER].
8. Press (A).
9. Use (C) to select the step reminder ON/OFF setting you want.

[OFF]	Step reminder function off
[ON]	Step reminder function on

10. Press (A) to complete the setting operation.  
 After the setting operation is complete, a check mark appears for a few seconds, and then the step reminder function setting screen re-appears.
11. Hold down (D) for at least one second to return to the current time screen.

### Note

- If you do not perform any operation for two or three minutes while the setting screen is displayed, the watch automatically returns to the current time screen.
- Even if step reminder is turned on, the watch will not perform notification if any one of the conditions below exists.
  - When the watch detects it is not being worn
  - While the current time is within the period defined by the bedtime and wake-up times you specified
  - While an activity is in progress
  - While the battery level indicator is **LOW** or lower
  - When there is a sensor error
- If behavior analysis does not detect walking and running, the watch may notify you that step reminder has determined that your step count is low.

### ● Clearing an Ongoing Notification

Press any button to clear an ongoing step reminder notification.

## Specifying the Night Time

Specify your night time.

After you specify your night time, you can link notification reception from your phone and your heart rate measurement settings NIGHT TIME.

1. Display the current time screen.  
🔍 Watch Mode
2. Hold down (C) for at least two seconds.  
 This enters the Control Mode.
3. Use (C) to select [SETTING].



4. Press (A).  
 This displays the setting menu screen.

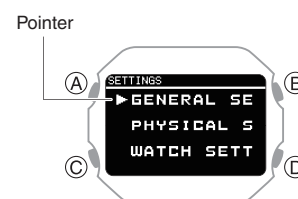

5. Use (C) to move the pointer to [GENERAL SETTINGS].
6. Press (A).  
 This displays the GENERAL SETTINGS screen.



7. Use (C) to move the pointer to [NIGHT TIME].

8. Press (A).

This causes a cursor to appear at the hour setting of the night time start time.

9. Use (C) to change the start time hour setting.

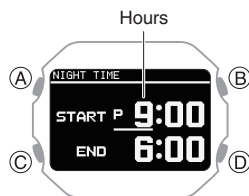

10. Press (A).

This causes the cursor to move to the start time minute setting.

11. Use (C) to change the start time minute setting.



12. Press (A).

This causes the cursor to move to the end time hour setting.

13. Use (C) to change the end time hour setting.



14. Press (A).

This causes the cursor to move to the end time minute setting.

15. Use (C) to change the end time minute setting.



16. Press (A) to complete the setting operation.

After the setting operation is complete, a check mark appears for a few seconds, and then the night time setting screen reappears.

17. Hold down (D) for at least one second to return to the current time screen.

### Note

- The allowable night time setting range is no shorter than six hours and no longer than 12 hours. If you configure a setting outside this range, the end time is automatically corrected, so the setting is within the allowable range.
- If you do not perform any operation for two or three minutes while the setting screen is displayed, the watch automatically returns to the current time screen.
- If sleep measurement is performed while [ACTIVITY & NIGHT TIME ON] is selected for heart rate measurement, sleep measurement will start from the time set for NIGHT TIME. For the NIGHT TIME time setting, specify your normal sleep time (bedtime and wake-up time).

## Configuring Sound and Vibration Settings

In addition to button operation and notification sounds and vibration, your watch also uses sound and vibration for alerts. You can use the procedure below to enable or disable sound and vibration.

### Note

- The pattern and duration of the sound or vibration cannot be changed.
  - Regardless of the beeper and vibration alert settings, illumination turns on when you perform a button operation or when an alert operation starts. Illumination that is turned on when a notification operation cannot be turned off. You may need to update your watch software to use to enable this specification.
- [Updating the Watch's Software Version](#)

## Configuring Operation Sound and Vibration Settings

1. Display the current time screen.  
[Watch Mode](#)
2. Hold down (C) for at least two seconds. This enters the Control Mode.
3. Use (C) to select [SETTING].



4. Press (A).

This displays the setting menu screen.

Pointer

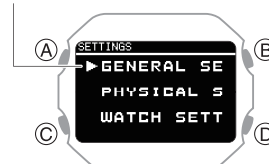

5. Use (C) to move the pointer to [GENERAL SETTINGS].

6. Press (A).

This displays the GENERAL SETTINGS screen.



7. Use (C) to move the pointer to [BEEP/ VIBE].

8. Press (A).

9. Use (C) to move the pointer to [BUTTON OPERATION].

10. Press (A).

11. Use (C) to select operation sound and vibration settings.

	Operation Tone	Operation Vibration
[BEEP+VIBE]	On	On
[BEEP]	On	Off
[VIBE]	Off	On
[OFF]	Off	Off

12. Press (A) to complete the setting operation.

After the setting operation is complete, a check mark appears for a few seconds, and then the sound and vibration setting screen re-appears.

13. Hold down (D) for at least one second to return to the current time screen.

### Note

- If you do not perform any operation for two or three minutes while the setting screen is displayed, the watch automatically returns to the current time screen.

## Configuring Notification Sound and Vibration Settings

1. Display the current time screen.

Watch Mode

2. Hold down (C) for at least two seconds.

This enters the Control Mode.

3. Use (C) to select [SETTING].



4. Press (A).

This displays the setting menu screen.

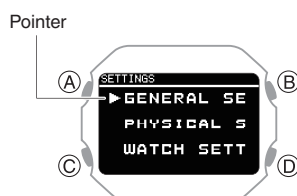

5. Use (C) to move the pointer to [GENERAL SETTINGS].

6. Press (A).

This displays the GENERAL SETTINGS screen.



7. Use (C) to move the pointer to [BEEP/ VIBE].

8. Press (A).

9. Use (C) to move the pointer to [NOTIFICATIONS].

10. Press (A).

11. Use (C) to select a notification sound and vibration settings.

	Notification Tone	Notification Vibration
[BEEP+VIBE]	On	On
[BEEP]	On	Off
[VIBE]	Off	On
[USER]	On only for user-specified setting items	
[OFF]	Off	Off

- [USER] setting items can be changed using the CASIO WATCHES phone app.

12. Press (A) to complete the setting operation.

After the setting operation is complete, a check mark appears for a few seconds, and then the sound and vibration setting screen re-appears.

13. Hold down (D) for at least one second to return to the current time screen.

### Note

- If you do not perform any operation for two or three minutes while the setting screen is displayed, the watch automatically returns to the current time screen.

## Configuring the Auto Light Setting

1. Display the current time screen.  
[Watch Mode](#)
2. Hold down (C) for at least two seconds.  
 This enters the Control Mode.
3. Use (C) to select [SETTING].



4. Press (A).  
 This displays the setting menu screen.

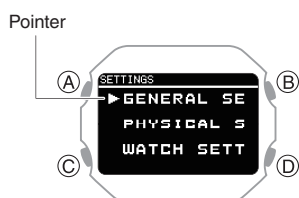

5. Use (C) to move the pointer to [GENERAL SETTINGS].
6. Press (A).  
 This displays the GENERAL SETTINGS screen.
7. Use (C) to move the pointer to [LIGHT].
8. Press (A).
9. Use (C) to move the pointer to [AUTO LIGHT].
10. Press (A).
11. Use (C) to move the pointer to [OFF] (disabled) or [ON] (enabled).
12. Press (A) to complete the setting operation.  
 After the setting operation is complete, a check mark appears for a few seconds, and then the auto light setting screen re-appears.
13. Hold down (D) for at least one second to return to the current time screen.

## Specifying the Illumination Duration

You can select either 1.5 seconds or five seconds as the illumination duration.

The illumination duration setting is applied as described below.

- Illumination triggered by a button operation
- Auto Light illumination
- Illumination that is triggered by Auto Lap, a notification, an alarm or some other notification operation

### Note

- You may need to update your watch software to enable illumination triggered by Auto Lap, a notification, an alarm, or some other notification operation.  
[Updating the Watch's Software Version](#)

1. Display the current time screen.  
[Watch Mode](#)
2. Hold down (C) for at least two seconds.  
 This enters the Control Mode.
3. Use (C) to select [SETTING].



4. Press (A).  
 This displays the setting menu screen.

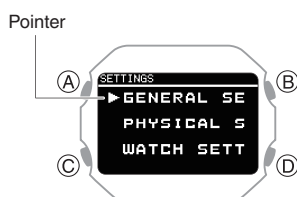

5. Use (C) to move the pointer to [GENERAL SETTINGS].

6. Press (A).  
 This displays the GENERAL SETTINGS screen.
7. Use (C) to move the pointer to [LIGHT].
8. Press (A).
9. Use (C) to move the pointer to [DURATION].
10. Press (A).
11. Press (C) to select an illumination duration.

[1.5s]	1.5-second illumination
[5.0s]	5-second illumination

12. Press (A) to complete the setting operation.  
 After the setting operation is complete, a check mark appears for a few seconds, and then the illumination duration setting screen re-appears.
13. Hold down (D) for at least one second to return to the current time screen.

### Note

- If you do not perform any operation for two or three minutes while the setting screen is displayed, the watch automatically returns to the current time screen.

## Enabling Power Saving

If you do not plan to use the product for a long time, you can conserve power by switching to power saving mode.

1. Display the current time screen.  
 Watch Mode
2. Hold down (C) for at least two seconds.  
 This enters the Control Mode.
3. Use (C) to select [SETTING].



4. Press (A).  
 This displays the setting menu screen.

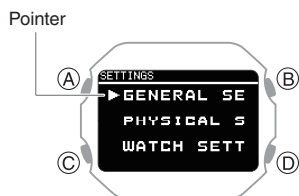

5. Use (C) to move the pointer to [GENERAL SETTINGS].
6. Press (A).  
 This displays the GENERAL SETTINGS screen.



7. Use (C) to move the pointer to [POWER SAVING].

8. Press (A).  
 This enables power saving and displays [HOLD DOWN THIS BUTTON] at the bottom of the screen.



### Note

- If you do not perform any operation for two or three minutes while the setting screen is displayed, the watch automatically returns to the current time screen.
- Alarm and hourly time signal notification operations are disabled in Power Saving mode.

## Disabling Power Saving

Hold down (D) for at least two seconds to disable power saving.

- Disabling power saving causes [HOLD DOWN THIS BUTTON] to disappear at the bottom of the screen.

## Changing the Length and Weight Units

You can select metric units (km, m, cm, kg) or imperial units (mile, yd, ft, lb) for length (height, distance) and weight (body weight) values.

### Important!

- When Tokyo (TOKYO) is the Home City, value units are fixed as metric (km, m, cm, kg) and cannot be changed.

1. Display the current time screen.  
 Watch Mode
2. Hold down (C) for at least two seconds.  
 This enters the Control Mode.
3. Use (C) to select [SETTING].



4. Press (A).  
 This displays the setting menu screen.

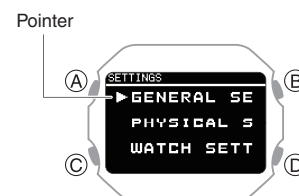

5. Use (C) to move the pointer to [GENERAL SETTINGS].
6. Press (A).  
 This displays the GENERAL SETTINGS screen.



7. Use (C) to move the pointer to [UNITS].
8. Press (A).
9. Use (C) to move the pointer to [LENGTH & WEIGHT].
10. Press (A).
11. Use (C) to select the length and weight units you want.

[km/m/cm & kg]	Metric System
[mile/yd/ft & lb]	Imperial System

12. Press (A) to complete the setting operation.  
After the setting operation is complete, a check mark appears for a few seconds, and then the unit setting screen reappears.
13. Hold down (D) for at least one second to return to the current time screen.

### Note

- If you do not perform any operation for two or three minutes while the setting screen is displayed, the watch automatically returns to the current time screen.
- You can also use the CASIO WATCHES phone app to change the length unit.

## Specifying the Calorie Display Unit

You can use the procedure below to select either calories (kcal) or joules (kJ) as the calories burned unit.

### Important!

- When Tokyo (TOKYO) is the Home City, the calories burned unit is fixed as kilocalories (kcal) and cannot be changed.

1. Display the current time screen.  
 Watch Mode
2. Hold down (C) for at least two seconds.  
This enters the Control Mode.
3. Use (C) to select [SETTING].



4. Press (A).  
This displays the setting menu screen.

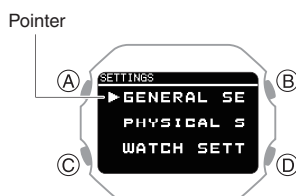

5. Use (C) to move the pointer to [GENERAL SETTINGS].
6. Press (A).  
This displays the GENERAL SETTINGS screen.



7. Use (C) to move the pointer to [UNITS].
8. Press (A).
9. Use (C) to move the pointer to [ENERGY].
10. Press (A).
11. Use (C) to select the calorie unit you want.

[kcal]	Kilocalories
[kJ]	Kilojoules

12. Press (A) to complete the setting operation.  
After the setting operation is complete, a check mark appears for a few seconds, and then the unit setting screen reappears.
13. Hold down (D) for at least one second to return to the current time screen.

### Note

- If you do not perform any operation for two or three minutes while the setting screen is displayed, the watch automatically returns to the current time screen.
- You can also use the CASIO WATCHES phone app to change the calories burned unit.

## Basic Information

This section provides the names of each watch part, as well as basic information and operations you need to know.

## General Guide

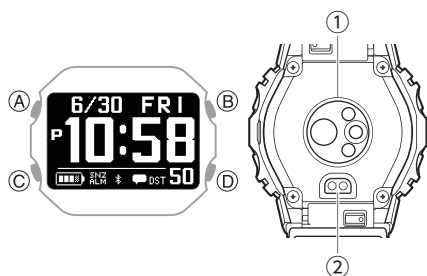

### A button

Press this button while the current time screen is displayed to switch to Activity Mode.

Pressing this button while any mode setting screen is displayed applies all of the screen's pending settings and changes.

### B button

Press to turn on illumination.

### C button

While the current time screen is displayed, press and hold this button for at least two seconds to switch to the Control Mode.

Pressing this button while a setting screen is displayed scrolls available menu items downwards.

### D button

Hold down this button for at least one second to return to the current time screen.

While configuring settings, pressing this button goes back to the previous screen.

### ① Optical sensor (heart rate detection)

Detects your pulse for heart rate measurement.

### ② Charging terminal

Plug in the charger cable here to connect to a device with a USB terminal for charging.

[Charging the Watch](#)

## Indicators

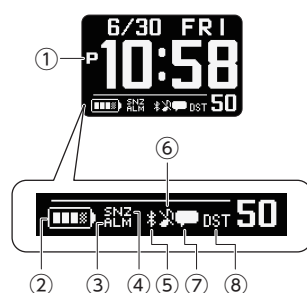

- ① Displayed during p.m. times while 12-hour timekeeping is being used.
- ② Shows the current battery level.
- ③ Displayed when an alarm or the smart alarm is turned on.
- ④ Displayed when an alarm or the smart alarm snooze function is turned on.
- ⑤ Airplane Mode/Bluetooth icon  
 : Displayed while the Airplane Mode is enabled.  
 : Displayed while there is a connection between the watch and a phone.
  - While re-connection with your phone is being attempted after loss of the connection, this indicator flashes at one-second intervals.
  - While re-connection with your phone is not being attempted after loss of the connection, this indicator flashes at two-second intervals.
- ⑥ Indicates the watch is in Silent Mode.
- ⑦ Appears when there are new notifications on your phone.
- ⑧ Displayed when the indicated time is summer time.

## Viewing the Face in the Dark

The watch has a light that illuminates the face for viewing in the dark.

- The light turns on each time you perform a button operation.
- Illumination is turned on when the sounds or vibrations start by Auto Lap, notification or alarm etc. Illumination that is turned on by a notification operation cannot be turned off.

### Note

- You may need to update your watch software to enable illumination triggered by Auto Lap, a notification, an alarm, or some other notification operation.  
[Updating the Watch's Software Version](#)

### ● To illuminate the face manually

Press (B) to turn on illumination.

- Illumination will turn off automatically if an alarm starts to sound.

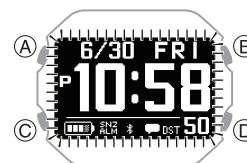

## ● Using Auto Light

If Auto Light is enabled, face illumination will turn on automatically whenever the watch is positioned at an angle of 40 degrees or more.

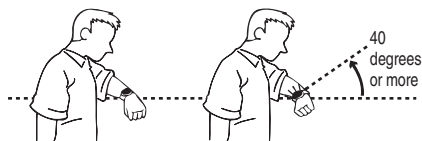

For information about enabling Auto Light, see the information below.

### 🔗 [Configuring the Auto Light Setting](#)

#### Important!

- Auto Light may not operate properly when the watch is at a horizontal angle of 15 degrees or greater from horizontal as shown in the illustration below.



- Electro-static charge or magnetism can interfere with proper auto light operation. If this happens, try lowering your arm and then angle it towards your face again.
- When moving the watch you may note a slight rattling sound. This is due to operation of the auto light switch, which determines the current orientation of the watch. It does not indicate malfunction.

## Fastening the Watch to Your Wrist

Correctly wearing the watch on your wrist is essential to obtain accurate heart rate, breathing exercise, and sleep measurements. Especially when using the watch while running or performing other strenuous exercises, make the adjustments described below to ensure that the watch does not shake or shift.

1. With the watch fastened loosely on your wrist, place at least one finger to the right of the watch\* (Figure).

\* If you wear the watch on your right wrist, place your finger(s) on the left side of the watch.

Figure

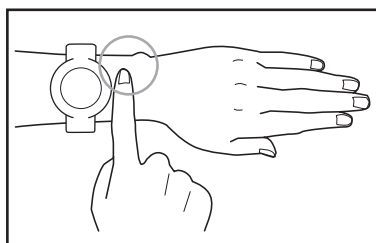

2. Position the watch so there is at least one finger width between it and the bone that protrudes from the side of your wrist (Figure).

- The location and shape of this bone (circled in the illustration) differ from person to person.

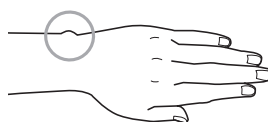

3. After you determine the best wrist position for the watch, tighten the band securely enough to keep the watch from sliding on your wrist.

#### Important!

- A band that is snugly tightened for heart rate or other measurements can make it difficult for air to pass under the band and cause you to sweat, which can lead to skin irritation. After measuring your heart rate, loosen the band enough so you can insert a finger between it and your wrist.
- Wearing the watch for long periods, sweat, or certain usage environments create the risk of skin rash. To prevent skin problems, regularly remove your watch from your wrist to give your skin some time to rest.
- The watch is not fastened correctly to your wrist if you can see green light coming out from behind the watch.
- Keep your arms still during breathing exercise measurement.
- For details about how to wear the watch during blood oxygen level measurements, see the information below.
  - 🔗 [Measuring Your Blood Oxygen Level](#)

## Updating the Watch's Software Version

Updating (upgrading) the watch software improves function and watch operation. Makes sure that you keep watch software updated to the latest version.

### ● Updating Watch Software

You should use the CASIO WATCHES phone app to update (upgrade) your watch's software.

A notification on the CASIO WATCHES phone app screen lets you know when a software update is available. Follow the instructions on the screen to update the software.

#### Check the connection

- Make sure the symbol is shown on the watch display when you perform the procedure below. If is not displayed, refer to the information at the link below. [Connecting with a Phone Paired With the Watch](#)

1. Tap the "CASIO WATCHES" icon.
2. Tap the "My Watch" tab.
3. Select "DW-H5600" and tap it.
4. Perform the operation shown on the screen to update the watch software version.

#### Important!

- Ensure the Watch Mode timekeeping screen is displayed when updating the watch software.
- Software updating can take up to 30 minutes.
- It is recommended that you have the watch connected to its charging cable and charging before you start a software update operation.
- If you are unable to update the software for some reason, visit the website below.

<https://support.casio.com/wat/app/3516/en/>

## Resetting Watch Settings

This section explains how to return the watch time, date, and other settings, as well as the log to their initial factory defaults.

#### Important!

- Once you perform a reset operation, you cannot restore pre-reset settings.
- Reset the watch settings is not possible under the conditions described below.
  - While the battery level indicator is or lower

1. Display the current time screen. Watch Mode
2. Hold down (C) for at least two seconds. This enters the Control Mode.
3. Use (C) to select [SETTING].



4. Press (A). This displays the setting menu screen.

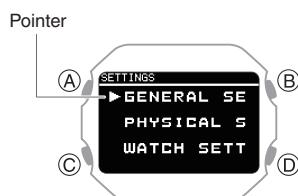

5. Use (C) to move the pointer to [GENERAL SETTINGS].
6. Press (A). This displays the GENERAL SETTINGS screen.
7. Use (C) to move the pointer to [RESET].
8. Press (A).

9. Use (C) to move the pointer to [YES].
  - To stop the reset operation, move the pointer to [NO].
10. Press (A).
 

After the reset operation is complete, the watch will return to the current time screen. The reset operation is complete when [AC] appears in the lower right corner of the display.
11. Press (A) to clear [AC] from the display.

#### Note

- Resetting the watch also deletes information for pairing the watch with a phone, and unpair them.

## Phone Finder

You can use phone finder to trigger a sound on the paired phone to help you find it. The sound operation is performed even if your phone is in vibrate mode.

### Important!

- Phone finder will not sound the tone unless the CASIO WATCHES phone app is running on the phone.
- Do not use this function in areas where phone call tones are restricted.
- The tone sounds at a high volume. Do not use this function when listening to phone output over earphones.

1. Display the current time screen.  
 Watch Mode
2. Hold down (C) for at least two seconds.  
 This enters the Control Mode.
3. Use (C) to select [PHONE FINDER].



4. Press (A).  
 This will establish a connection between the watch and phone, and sound the phone's ringtone.
  - It takes a few seconds before the phone tone sounds.
  - [FAILED] appears when a phone finder operation is unsuccessful.
5. Press any button to stop the sound.
  - You can press any watch button to stop the phone tone only during the first 30 seconds after it starts to sound.

### Note

- Connection with your phone is not possible while the watch's Airplane Mode is enabled. To connect with your phone, disable the Airplane Mode.  
[Entering the Watch Airplane Mode](#)

## Entering the Watch Airplane Mode

When you are in a hospital, on an aircraft, or in any other location where connection with a phone may cause problems, turn on the watch's Airplane Mode. To turn off the Airplane Mode, perform the same operation again.

1. Display the current time screen.  
 Watch Mode
2. Hold down (C) for at least two seconds.  
 This enters the Control Mode.
3. Use (C) to select [AIRPLANE MODE].



4. Press (A).
5. Use (C) to select an Airplane Mode setting.
 

[OFF]	Exits Airplane Mode.
[ON]	Enables Airplane Mode.
6. Press (A) to complete the setting operation.  
 After the setting operation is complete, a check mark appears for a few seconds, and then the Airplane Mode screen reappears.
7. Press (D) to exit the setting screen.
  - is displayed while the watch is in the Airplane Mode.

## Specifications

### Accuracy :

±15 seconds per month when time adjustment by communication with a phone is not possible.

### Basic Functions :

Hour, minute, second, month, day, day of the week  
 a.m./p.m. (P), 24-hour timekeeping  
 Full Auto Calendar (2000 to 2099)

### Mobile Link :

Function linking by wireless connection with Bluetooth® compatible devices\*

\* Operation enhanced by Mobile Link  
 Auto Time Correction

Simple time setting

Function re-ordering and number of function specification

World Time: Current time in 300 cities (38 time zones, auto summer time switching), and UTC (Coordinated Universal Time) time

Watch settings

Data updating

Updating of time zone and summer time rule information

Activity function setup

Activity re-ordering and number of activity  
 Activity display customization  
 Target alert setting (time, distance, calories burned)

Activity log data management

Activity log data, lap data management  
 Training analysis results

Notifications

Phone finder

Communication Specifications

Bluetooth®

Frequency band: 2400 MHz to 2480 MHz

Transmission power: 1.6 mW (2 dBm)

Communication range: Up to 2 meters (depends on environment)

## Activity Function :

Multi-sports (running, walking, etc.)  
Distance, speed, pace, and other information calculated using accelerometer data  
Auto/Manual lap  
Auto Pause

## Training Analysis :

Cardio load status

## Activity log data :

Up to 100 runs, up to 200 lap records per run  
Measurement time, distance, pace, running index (when phone GPS is used), calories burned, energy source used, heart rate, maximum heart rate, cardio load, cadence, maximum cadence, stride

## Wrist heart rate measurement :

Measurement range: 30 to 220 bpm  
Target heart rate setting  
Graphic heart rate zones  
Heart rate graph  
Maximum/minimum heart rate

## Step Count :

Step count measurement using a 3-axis accelerometer  
Step count display range: 0 to 99,999 steps  
Step count reset: Auto reset at midnight each day

## Blood Oxygen Level\* :

Measurement range: 80% to 100%  
Measurement unit: 1%  
\* The blood oxygen level measurement function is not intended as a medical device for diagnosing specific diseases. It is intended for general health maintenance only.

## Sleep Measurement :

Sleep recovery status: 6 stages  
Sleep recovery level display  
Sleep status: 5 stages  
Sleep score display range: 1 to 100  
Measurement unit: 1  
Autonomic nerve status: 5 stages  
ANS score range: -10 to +10  
Measurement unit: 0.1

## Breathing Exercise :

Setting range: 2 to 20 minutes  
Setting unit: 1 minute  
Biofeedback  
Summary of time spent in each zone

## Life Log :

Step Count  
Step graph (week, month, 6 months)  
Calories burned measurement  
Active time measurement

## Almanac :

Sunrise/Sunset times ([--:--] displayed when calculation results cannot be output for some reason or in regions outside of 65.0° south to 65.0° north latitude.)  
Moon age

## Stopwatch :

Measuring unit: 1 second  
Measuring capacity: 99:59'59" (100 hours)  
Split times

## Timer :

Setting unit: 1 second  
Measuring unit: 1 second  
Maximum setting: 60 minutes

## World Time :

Displays current time in 38 cities (38 time zones)\* and UTC, Auto DST  
\* Subject to updates by connection between the watch and a phone.

## Other :

Power Saving  
LED backlight (Full Auto Light, Super Illuminator, afterglow, 1.5 or 5-second selectable illumination duration)  
Charge Level Indication  
Operation sound enable/disable  
Vibration  
Airplane Mode  
4 alarms (with snooze)  
Smart alarm (with snooze)  
Step reminder

## Accessories :

Charger cable  
When unpackaging, check to make sure everything is included. If something is missing, contact your original retailer.

## Power Supply :

Lithium-ion battery

## Power Consumption :

0.0W\*  
\* Measured standby power measurement per (EU)2023/826

## Battery Operating Time :

The battery operating times in the table below are intended as general guidelines. Operating time differs according display time and how the watch is used.

### Watch Mode

Settings	Battery Operating Time (Approx.)
Heart rate *1 + Sleep	
[ACTIVITY & NIGHT TIME ON] + Worn during sleep (8 hours)	6 days
[ACTIVITY & NIGHT TIME ON] + Not worn during sleep	1 month
[ON] + Worn during sleep (8 hours)	3 days
[ON] + Not worn during sleep	4 days
[OFF]	1 month

### Activity Mode

Settings	Battery Operating Time (Approx.)
Heart Rate *1	
[ACTIVITY & NIGHT TIME ON] or [ON]	35 hours

\*1 Heart rate measurement settings

- [ACTIVITY & NIGHT TIME ON]: Enable during activities and night time only
- [ON]: Always enabled
- [OFF]: Always off (No measurement while sleeping.)

Specifications are subject to change without notice.

## Other Information

This section provides non-operational information you also need to know. Refer to this information as required.

### City Table

City	City	Offset
UTC	Coordinated Universal Time	0
LONDON	London	0
PARIS	Paris	+1
ATHENS	Athens	+2
JEDDAH	Jeddah	+3
TEHRAN	Tehran	+3.5
DUBAI	Dubai	+4
KABUL	Kabul	+4.5
KARACHI	Karachi	+5
DELHI	Delhi	+5.5
KATHMANDU	Kathmandu	+5.75
DHAKA	Dhaka	+6
YANGON	Yangon	+6.5
BANGKOK	Bangkok	+7
HONG KONG	Hong Kong	+8
EUCLA	Eucla	+8.75
TOKYO	Tokyo	+9
ADELAIDE	Adelaide	+9.5
SYDNEY	Sydney	+10
LORD HOWE ISLAND	Lord Howe Island	+10.5
NOUMEA	Noumea	+11
WELLINGTON	Wellington	+12
CHATHAM ISLAND	Chatham Islands	+12.75
NUKU'ALOFA	Nuku'alofa	+13
KIRITIMATI	Kiritimati	+14
BAKER ISLAND	Baker Island	-12
PAGO PAGO	Pago Pago	-11
HONOLULU	Honolulu	-10
MARQUESAS ISLANDS	Marquesas Islands	-9.5
ANCHORAGE	Anchorage	-9
LOS ANGELES	Los Angeles	-8
DENVER	Denver	-7
CHICAGO	Chicago	-6
NEW YORK	New York	-5
HALIFAX	Halifax	-4
ST. JOHN'S	St. John's	-3.5
RIO DE JANEIRO	Rio de Janeiro	-3
FERNANDO DE NORONHA	Fernando de Noronha	-2
PRAIA	Praia	-1

- The information in the above table is current as of July 2022.
- Time zones may change and UTC differentials may become different from those shown in the table above. If this happens, connect the watch with a phone to update the watch with the latest time zone information.

### Summer Time Table

When [AUTO] is selected for a city that observes summer time, switching between standard time and summer time will be performed automatically at the timing shown in the table below.

#### Note

- Summer time start and end dates for your current location may be different from those shown below. If this happens, you can have new summer time information for your Home City and World Time City sent to the watch by connecting the watch with a phone. If the watch is not connected with a phone, you can change the summer time setting manually.

City Name	Summer Time Start	Summer Time End
London	01:00, last Sunday in March	02:00, last Sunday in October
Paris	02:00, last Sunday in March	03:00, last Sunday in October
Athens	03:00, last Sunday in March	04:00, last Sunday in October
Tehran	00:00, March 22 or 21	00:00, September 22 or 21
Sydney, Adelaide	02:00, first Sunday in October	03:00, first Sunday in April
Lord Howe Island	02:00, first Sunday in October	02:00, first Sunday in April
Wellington	02:00, last Sunday in September	03:00, first Sunday in April
Chatham Islands	02:45, last Sunday in September	03:45, first Sunday in April
Anchorage	02:00, second Sunday in March	02:00, first Sunday in November
Los Angeles	02:00, second Sunday in March	02:00, first Sunday in November
Denver	02:00, second Sunday in March	02:00, first Sunday in November
Chicago	02:00, second Sunday in March	02:00, first Sunday in November
New York	02:00, second Sunday in March	02:00, first Sunday in November
Halifax	02:00, second Sunday in March	02:00, first Sunday in November
St. John's	02:00, second Sunday in March	02:00, first Sunday in November

- The information in the above table is current as of July 2022.

## Fitness Categories

### Men

Age	Evaluation	Value
24 or below	VERY LOW	<32
	LOW	32-37
	FAIR	38-43
	MODERATE	44-50
	GOOD	51-56
	VERY GOOD	57-62
	ELITE	>62
25-29	VERY LOW	<31
	LOW	31-35
	FAIR	36-42
	MODERATE	43-48
	GOOD	49-53
	VERY GOOD	54-59
	ELITE	>59
30-34	VERY LOW	<29
	LOW	29-34
	FAIR	35-40
	MODERATE	41-45
	GOOD	46-51
	VERY GOOD	52-56
	ELITE	>56
35-39	VERY LOW	<28
	LOW	28-32
	FAIR	33-38
	MODERATE	39-43
	GOOD	44-48
	VERY GOOD	49-54
	ELITE	>54
40-44	VERY LOW	<26
	LOW	26-31
	FAIR	32-35
	MODERATE	36-41
	GOOD	42-46
	VERY GOOD	47-51
	ELITE	>51
45-49	VERY LOW	<25
	LOW	25-29
	FAIR	30-34
	MODERATE	35-39
	GOOD	40-43
	VERY GOOD	44-48
	ELITE	>48
50-54	VERY LOW	<24
	LOW	24-27
	FAIR	28-32
	MODERATE	33-36
	GOOD	37-41
	VERY GOOD	42-46
	ELITE	>46
55-59	VERY LOW	<22
	LOW	22-26
	FAIR	27-30
	MODERATE	31-34
	GOOD	35-39
	VERY GOOD	40-43
	ELITE	>43

Age	Evaluation	Value
60 or above	VERY LOW	<21
	LOW	21-24
	FAIR	25-28
	MODERATE	29-32
	GOOD	33-36
	VERY GOOD	37-40
	ELITE	>40

### Women

Age	Evaluation	Value
24 or below	VERY LOW	<27
	LOW	27-31
	FAIR	32-36
	MODERATE	37-41
	GOOD	42-46
	VERY GOOD	47-51
	ELITE	>51
25-29	VERY LOW	<26
	LOW	26-30
	FAIR	31-35
	MODERATE	36-40
	GOOD	41-44
	VERY GOOD	45-49
	ELITE	>49
30-34	VERY LOW	<25
	LOW	25-29
	FAIR	30-33
	MODERATE	34-37
	GOOD	38-42
	VERY GOOD	43-46
	ELITE	>46
35-39	VERY LOW	<24
	LOW	24-27
	FAIR	28-31
	MODERATE	32-35
	GOOD	36-40
	VERY GOOD	41-44
	ELITE	>44
40-44	VERY LOW	<22
	LOW	22-25
	FAIR	26-29
	MODERATE	30-33
	GOOD	34-37
	VERY GOOD	38-41
	ELITE	>41
45-49	VERY LOW	<21
	LOW	21-23
	FAIR	24-27
	MODERATE	28-31
	GOOD	32-35
	VERY GOOD	36-38
	ELITE	>38
50-54	VERY LOW	<19
	LOW	19-22
	FAIR	23-25
	MODERATE	26-29
	GOOD	30-32
	VERY GOOD	33-36
	ELITE	>36

Age	Evaluation	Value
55-59	VERY LOW	<18
	LOW	18-20
	FAIR	21-23
	MODERATE	24-27
	GOOD	28-30
	VERY GOOD	31-33
	ELITE	>33
60 or above	VERY LOW	<16
	LOW	16-18
	FAIR	19-21
	MODERATE	22-24
	GOOD	25-27
	VERY GOOD	28-30
	ELITE	>30

Source:

Shvartz E Reibold RC: Aerobic fitness norms for males and females aged 6 to 75 years: a review. Aviat Space Environ Med;61:3-11 1990 Shvartz E, Reibold RC.

## Supported Phones

For information about phones that can connect with the watch, visit the CASIO website.

[https://world.casio.com/os\\_mobile/wat/](https://world.casio.com/os_mobile/wat/)

## Message Screen List

Indicator:	Meaning:
	Watch battery level is low. Charge the watch.
	Insufficient remaining memory capacity.
	Memory is full.
	Bluetooth reception in progress
	Phone connection complete.
	Connection/pairing with your phone failed. Try again.
	Keep the watch still during measurement. Press (A) to start measurement.
	Measurement in progress. Please wait.
	Please wait
	No data
	Watch error. There may be a problem with the sensor. Remeasure or re-calibrate.
	Watch setup reset in progress

## Checking Wireless Compliance Information

1. Display the current time screen.  
 Watch Mode
2. Hold down (C) for at least two seconds. This enters the Control Mode.
3. Use (C) to select [SETTING].



4. Press (A). This displays the setting menu screen.

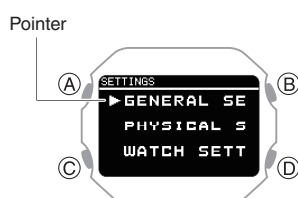

5. Use (C) to move the pointer to [REGULATORY].
6. Press (A).
7. Use (C) to select the information you want to view.
8. Hold down (D) for at least one second to return to the current time screen.

## Copyrights and Registered Copyrights

- The Bluetooth® word mark and logos are registered trademarks owned by the Bluetooth SIG, Inc. and any use of such marks by CASIO Computer Co., Ltd. is under license.
- iPhone and App Store are trademarks of Apple Inc. in the United States and other countries.
- iOS is a trademark or registered trademark of Cisco Systems, Inc.
- Android and Google Play™ are trademarks or registered trademarks of Google LLC.
- Nightly Recharge™ and Sleep Plus Stages™ are registered trademarks of Polar Electro Oy.
- Other company names and product names used herein are trademarks or registered trademarks of their respective companies.

## Software

Use the URL below to access information about software.

<https://s.casio.jp/w/10382en/>

## Troubleshooting

### Charging with the Charger Cable

**Q1** The watch won't charge with the charger cable.

Is the end of the charger cable with the special watch connector securely aligned with the watch charger terminal?

Charging may fail if there is space between the terminals.

🔗 [Precautions When Charging](#)

Did you leave the watch attached to the charger cable after charging was complete?

Charging stops automatically after the watch becomes fully charged. If you want to charge again, unplug the charger cable from the watch and then re-attach it.

Is charging still impossible after checking the above points?

Check to make sure that the USB device or power source is functioning normally.

**Q2** Charging stops before it is complete.

Charging may stop if some temporary abnormality occurs. Unplug the charger cable from the watch and check for abnormalities. If there is nothing wrong, try charging again. If the above does not eliminate the problem, contact your original retailer or a CASIO service center.

### I can't pair the watch with a phone.

**Q1** I've never been able to establish a (pairing) connection between the watch and phone.

Are you using a supported phone model?

Check if the phone model and its operating system are supported by the watch.

For information about supported phone models, visit the CASIO Website.

🔗 [https://world.casio.com/os\\_mobile/wat/](https://world.casio.com/os_mobile/wat/)

Did you install the CASIO WATCHES phone app on your phone?

The CASIO WATCHES phone app needs to be installed on your phone in order to connect with the watch.

🔗 [① Install the required app on your phone.](#)

Did you enable location services?

On your phone, configure the settings below. For details about setting procedures, see your phone documentation.

- Enable your phone's location services.
- Give your phone rights to use the phone app's location information.

Are your phone's Bluetooth settings configured correctly?

Configure the phone's Bluetooth settings. For details about setting procedures, see your phone documentation.

#### iPhone Users

- "Settings" → "Bluetooth" → On
- "Settings" → "Privacy" → "Bluetooth" → "CASIO WATCHES" → On

#### Android Users

- Enable Bluetooth.

Other than the above.

Some phones need to have BT Smart disabled to use the CASIO WATCHES phone app. For details about setting procedures, see your phone documentation.

On the Home Screen, tap: "Menu" → "Settings" → "Bluetooth" → "Menu" → "BT Smart settings" → "Disable".

### I can't reconnect the watch and phone.

**Q1** The watch will not re-connect with the phone after they are disconnected.

Is the CASIO WATCHES phone app running?

The watch cannot re-connect with your phone unless the CASIO WATCHES phone app is running on the phone. On your phone's home screen, tap the CASIO WATCHES icon. Perform the operation shown on the screen that appears to pair with the watch.

🔗 [④ Pair the watch with your phone](#)

Have you tried turning your phone off and then back on again?

Turn your phone off and then back on again, and then tap the CASIO WATCHES icon. Perform the operation shown on the screen to pair with the watch.

🔗 [④ Pair the watch with your phone](#)

**Q2** I can't connect while my phone is in the Airplane Mode.

Connection with the watch is not possible while the phone's Airplane Mode is enabled. Disable your phone's Airplane Mode. On its home screen, tap the "CASIO WATCHES" icon. Next, perform the operation shown on the screen to pair with the watch.

🔗 [④ Pair the watch with your phone](#)

**Q3** I can't connect while the watch is in the Airplane Mode.

Exit the watch's Airplane Mode.

🔗 [Entering the Watch Airplane Mode](#)

**Q4** I changed the phone's Bluetooth from enabled to disabled, and now I can't connect anymore.

On your phone, turn on Bluetooth. Then on its home screen, tap the "CASIO WATCHES" icon. Next, perform the operation shown on the screen to pair with the watch.

🔗 [④ Pair the watch with your phone](#)

**Q5** I can't connect after turning off the phone.

Turn on your phone. On its home screen, tap the CASIO WATCHES icon. Next, perform the operation shown on the screen to pair with the watch.

🔍 ④ [Pair the watch with your phone](#)

**I can't seem to be able to connect, or connection is unstable.**

**Q1** I can't establish a connection between the phone and watch.

Have you tried turning your phone off and then back on again?

Turn your phone off and then back on again, and then tap the CASIO WATCHES icon. Perform the operation shown on the screen to pair with the watch.

🔍 ④ [Pair the watch with your phone](#)

Is the watch in the Airplane Mode?

Connection with your phone is not possible while the watch's Airplane Mode is enabled. To connect with your phone, disable the Airplane Mode.

🔍 [Entering the Watch Airplane Mode](#)

Has the watch been re-paired with the phone?

After deleting the pairing information from the CASIO WATCHES phone app and your phone, re-pair the watch and phone.

🔍 [Unpairing](#)

🔍 ④ [Pair the watch with your phone](#)

If you are unable to establish a connection...

After deleting pairing information from the watch, re-pair it with your phone.

🔍 [Deleting Pairing Information from the Watch](#)

🔍 ④ [Pair the watch with your phone](#)

## Changing to a Different Phone Model

**Q1** How do I connect my watch to a different phone?

Pair the watch with the phone.

🔍 [After Purchasing Another Phone](#)

## Auto Time Correction by Bluetooth Connection (Time Correction)

**Q1** When does the watch correct its time?

Your watch can connect with a paired phone to adjust its time setting. Auto time correction is performed at the times described below.

- After your phone's time zone or summer time setting is changed
- After 24 hours or more have passed since the last time adjustment using Bluetooth connection
- After 24 hours or more have passed since the last home city change or time adjustment using watch operation

**Q2** Auto time setting is not correct.

Is ✂ displayed?

To preserve battery power, the watch will automatically terminate Bluetooth connection with your phone temporarily if it detects the connection has been unused for approximately one hour. Auto Time Correction is disabled while there is no connection. To reconnect, press any watch button or angle the watch towards your face.

Have 24 hours or more passed since the last time adjustment using Bluetooth connection?

Note that auto time correction is not performed for 24 hours after you adjust the time setting manually on the watch. Auto time correction will resume after 24 hours.

Have 24 hours or more passed since the last manual time adjustment or city change?

Auto time correction is not performed for 24 hours after a manual time adjustment or city change. Auto time correction will resume after 24 hours or more have elapsed after either of the above operations is performed.

Is the watch's Airplane Mode enabled?

Connection with your phone is not possible while the watch's Airplane Mode is enabled. To connect with your phone, disable the Airplane Mode.

🔍 [Entering the Watch Airplane Mode](#)

**Q3** Time is not displayed correctly.

The phone's time setting may be incorrect because it is unable to connect with its network due to being out of range, etc. If this happens, connect the phone to its network and then adjust the time setting.

## Activity Log and Life Log

**Q1** How much Activity Log and Life Log data does the watch store?

The data storage capacity of watch memory is shown below.

- Activity Log: 100 records
- Life Log: 3 days

If there is a lot of data, it will take time to transfer the data to the CASIO WATCHES phone app. Frequent connection to the CASIO WATCHES to transfer data is recommended.

## Nightly Recharge™

**Q1** Sleep measurement (Nightly Recharge™) results are not displayed.

Sleep data cannot be acquired when any of the following conditions exist.

- Your actual sleep time does not match the current bedtime/wake-up time setting
- Sleep (from bedtime to wake up) of less than 4 hours
- Wearing the watch only while asleep and taking it off immediately after awaking
- Something other than [ON] or [ACTIVITY & NIGHT TIME ON] is selected for the heart rate measurement setting
- The watch is not fastened securely to your wrist while sleeping
- A minimum of three sleep measurement operations (one of which was the night before) not performed within the past 28 days

## Heart Rate Measurement

**Q1** [ERROR] is displayed during measurement.

There may be a problem with the sensor. Try taking another measurement. If [ERROR] keeps appearing after multiple measurement attempts, contact a CASIO service center or your original retailer.

## Pedometer

**Q1** Displayed step count is not correct.

While the watch is on your wrist, it may detect non-step movements and count them as steps.

[Counting Steps](#)

Also, step count problems can also be caused by how the watch is being worn and abnormal arm movement while walking.

[Causes of Incorrect Step Count](#)

**Q2** The step count does not increase.

To prevent erroneous counting, the count display does not increase immediately after you start walking.

**Q3** [ERROR] appears when using the pedometer.

[ERROR] (error) is displayed when sensor operation is disabled because of sensor or internal circuitry malfunction.

If the indicator remains on the display for more than three minutes or if it frequently appears, it could indicate a faulty sensor.

Contact a CASIO service center or your original retailer.

## Alarm

**Q1** There is no sound and/or vibration operation performed for alarms.

Is the watch's battery charged?

Charge the watch until the battery is sufficiently recharged.

[Charging](#)

Is alarm sound and/or vibration enabled?

Enable the alarm.

[Turning Off an Alarm](#)

## Other

**Q1** I can't find the information I need here.

Visit the website below.

<https://world.casio.com/support/>

## Precautions

### Operating Precautions

#### ● Water Resistance

- The information below applies to watches with WATER RESIST or WATER RESISTANT marked on the back cover.

#### Water Resistance Under Daily Use

Marking on watch front or on back cover	No BAR mark
---	-------------

#### Example of Daily Use

Hand washing, rain	Yes
Water-related work, swimming	No
Windsurfing	No
Skin diving	No

#### Enhanced Water Resistance Under Daily Use

##### 5 Atmospheres

Marking on watch front or on back cover	5BAR
---	------

#### Example of Daily Use

Hand washing, rain	Yes
Water-related work, swimming	Yes
Windsurfing	No
Skin diving	No

##### 10 Atmospheres

Marking on watch front or on back cover	10BAR
---	-------

#### Example of Daily Use

Hand washing, rain	Yes
Water-related work, swimming	Yes
Windsurfing	Yes
Skin diving	Yes

##### 20 Atmospheres

Marking on watch front or on back cover	20BAR
---	-------

#### Example of Daily Use

Hand washing, rain	Yes
Water-related work, swimming	Yes
Windsurfing	Yes
Skin diving	Yes

- Do not use your watch for scuba diving or other types of diving that requires air tanks.
- Watches that do not have WATER RESIST or WATER RESISTANT marked on the back cover are not protected against the effects of sweat. Avoid using such a watch under conditions where it will be exposed to large amounts of sweat or moisture, or to direct splashing with water.
- Even if a watch is water resistant, note the usage precautions described below. Such types of use reduce water resistance performance and can cause fogging of the glass.
  - Do not operate the crown or buttons while your watch is submersed in water or wet.
  - Avoid wearing your watch while in the bath.
  - Do not wear your watch while in a heated swimming pool, sauna, or any other high temperature/high humidity environment.
  - Do not wear your watch while washing your hands or face, while doing housework, or while performing any other task that involves soaps or detergents.
- After submersion in seawater, use plain water to rinse all salt and dirt from your watch.
- To maintain water resistance, have the gaskets of your watch replaced periodically (about once every two or three years).
- A trained technician will inspect your watch for proper water resistance whenever you have its battery replaced. Battery replacement requires the use of special tools. Always request battery replacement from your original retailer or from an authorized CASIO service center.
- Some water-resistant watches come with fashionable leather bands. Avoid swimming, washing, or any other activity that causes direct exposure of a leather band to water.
- The inside surface of the watch glass may fog when the watch is exposed to a sudden drop in temperature. No problem is indicated if the fogging clears up relatively quickly. Sudden and extreme temperature changes (such as coming into an air conditioned room in the summer and standing close to an air conditioner outlet, or leaving a heated room in the winter and allowing your watch to come into contact with snow) can cause it to take longer for glass fogging to clear up. If glass fogging does not clear up or if you notice moisture inside of the glass, immediately stop using your watch and take it to your original retailer or to an authorized CASIO service center.
- Your water-resistant watch has been tested in accordance with International Organization for Standardization regulations.
- Band**
  - Tightening the band too tightly can cause you to sweat and make it difficult for air to pass under the band, which can lead to skin irritation. Do not fasten the band too tightly. There should be enough room between the band and your wrist so you can insert your finger.
  - Deterioration, rust, and other conditions can cause the band to break or come off of your watch, which in turn can cause band pins to fly out of position or to fall out. This creates the risk of your watch falling from your wrist and becoming lost, and also creates the risk of personal injury. Always take good care of your band and keep it clean.
  - Immediately stop using a band if you even notice any of the following: loss of band flexibility, band cracks, band discoloration, band looseness, band connecting pin flying or falling out, or any other abnormality. Take your watch to your original retailer or to a CASIO service center for inspection and repair (for which you will be charged) or to have the band replaced (for which you will be charged).

## ● Temperature

- Never leave your watch on the dashboard of a car, near a heater, or in any other location that is subject to very high temperatures. Do not leave your watch where it will be exposed to very low temperatures. Temperature extremes can cause your watch to lose or gain time, to stop, or otherwise malfunction.
- Leaving your watch in an area hotter than +60 °C (140 °F) for long periods can lead to problems with its LCD. The LCD may become difficult to read at temperatures lower than 0 °C (32 °F) and greater than +40 °C (104 °F).

## ● Impact

- Your watch is designed to withstand impact incurred during normal daily use and during light activity such as playing catch, tennis, etc. Dropping your watch or otherwise subjecting it to strong impact, however, can lead to malfunction. Note that watches with shock-resistant designs (G-SHOCK, BABY-G, G-MS) can be worn while operating a chain saw or engaging in other activities that generate strong vibration, or while engaging in strenuous sports activities (motocross, etc.)

## ● Magnetism

- Though a digital watch normally is not affected by magnetism, very strong magnetism (from medical equipment, etc.) should be avoided because it can cause malfunction and damage to electronic components.

## ● Electrostatic Charge

- Exposure to very strong electrostatic charge can cause your watch to display the wrong time. Very strong electrostatic charge even can damage electronic components.
- Electrostatic charge may cause temporary blotching in blank areas of the LCD.

## ● Chemicals

- Do not allow your watch to come into contact with thinner, gasoline, solvents, oils, or fats, or with any cleaners, adhesives, paints, medicines, or cosmetics that contain such ingredients. Doing so can cause discoloration or damage to the resin case, resin band, leather, and other parts.

## ● Storage

- If you do not plan to use your watch for a long time, thoroughly wipe it free of all dirt, sweat, and moisture, and store it in a cool, dry place.

## ● Resin Components

- Allowing your watch to remain in contact with other items or storing it together with other items for long periods while it is wet can cause color on resin components to transfer to the other items, or the color of the other items to transfer to the resin components of your watch. Be sure to dry off your watch thoroughly before storing it and make sure it is not in contact with other items.
- Leaving your watch where it is exposed to direct sunlight (ultraviolet rays) for long periods or failure to clean dirt from your watch for long periods can cause it to become discolored.
- Friction caused by certain conditions (strong external force, sustained rubbing, impact, etc.) can cause discoloration of painted components.
- If there are printed figures on the band, strong rubbing of the printed area can cause discoloration.
- Leaving your watch wet for long periods can cause fluorescent color to fade. Wipe the watch dry as soon as possible after it becomes wet.
- Semi-transparent resin parts can become discolored due to sweat and dirt, and if exposed to high temperatures and humidity for long periods.
- Daily use and long-term storage of your watch can lead to deterioration, breaking, or bending of resin components. The extent of such damage depends on usage conditions and storage conditions.

## ● Leather Band

- Allowing your watch to remain in contact with other items or storing it together with other items for long periods while it is wet can cause the color of the leather band to transfer to the other items or the color of the other items to transfer to the leather band. Be sure to dry off your watch thoroughly with a soft cloth before storing it and make sure it is not in contact with other items.
- Leaving a leather band where it is exposed to direct sunlight (ultraviolet rays) for long periods or failure to clean dirt from a leather band for long periods can cause it to become discolored.

### CAUTION:

Exposing a leather band to rubbing or dirt can cause color transfer and discoloration.

## ● Metal Components

- Failure to clean dirt from metal components can lead to formation of rust, even if components are stainless steel or plated. If metal components exposed to sweat or water, wipe thoroughly with a soft, absorbent cloth and then place the watch in a well-ventilated location to dry.
- Use a soft toothbrush or similar tool to scrub the metal with a weak solution of water and a mild neutral detergent, or with soapy water. Next, rinse with water to remove all remaining detergent and then wipe dry with a soft absorbent cloth. When washing metal components, wrap the watch case with kitchen plastic wrap so it does not come into contact with the detergent or soap.

## ● Bacteria and Odor Resistant Band

- The bacteria and odor resistant band protects against odor generated by the formation of bacteria from sweat, which ensures comfort and hygiene. In order to ensure maximum bacteria and odor resistance, keep the band clean. Use an absorbent soft cloth to thoroughly wipe the band clean of dirt, sweat, and moisture. A bacteria and odor resistant band suppresses the formation of organisms and bacteria. It does not protect against rash due to allergic reaction, etc.

## ● Liquid Crystal Display

- Display figures may be difficult to read when viewed from an angle.

## ● Watch with Data Memory

- Allowing the battery to go dead, replacing the battery, or having your watch repaired can cause all data in watch memory to be lost. Note that CASIO Computer Co., Ltd. assumes no responsibility for any damages or losses caused by data lost due to malfunction or repair of your watch, replacement of the battery, etc. Be sure to keep separate written copies of all important data.

## ● Watch Sensors

- A watch sensor is a precision instrument. Never try to take it apart. Never try to insert any objects into the openings of a sensor, and take care to ensure that dirt, dust, or other foreign matter does not get into it. After using your watch where it has been immersed in saltwater, rinse it thoroughly with fresh water.

## ● Heart Rate Monitor Functions

- The back cover of the watch has a built-in sensor that detects your pulse. This is used to calculate and display an approximate heart rate value. The factors below can cause error in the displayed heart rate value.
  - How the watch is affixed to the wrist
  - Individual wrist characteristics and conditions
  - Training type and intensity
  - Sweat, dirt, and/or other foreign matter near the sensor

All of this means that heart rate values displayed by the watch are approximate, and no guarantees are made concerning their accuracy.

- The heart rate monitor function of this watch is intended for recreational purposes, and should not be used in any way for medical purposes.

## ● Chargeable Battery Handling (Please recycle!)

The built-in lithium-ion battery includes valuable resources. When you are ready to discard your watch, follow proper procedures in order to recycle resources. For information about the proper procedure to follow when discarding the watch, contact an authorized CASIO service center or your original retailer.

### Important!

- Do not try to replace batteries by yourself. Request battery replacement from an authorized CASIO service center or your original retailer.

## ● Personal Information Protection Precautions

To protect your personal information, be sure to perform the operation under “Resetting Watch Settings” before transferring ownership of this watch to another party or before disposing of it.

Note that CASIO Computer Co., Ltd. assumes no responsibility for any damage or loss suffered by you or any third party arising through the use of your watch or its malfunction.

## User Maintenance

### ● Caring for Your Watch

Remember that you wear your watch next to your skin, just like a piece of clothing. To ensure your watch performs at the level for which it is designed, keep it clean by frequently wiping with a soft cloth to keep your watch and band free of dirt, sweat, water and other foreign matter.

- Whenever your watch is exposed to sea water or mud, rinse it off with clean fresh water.
- For a metal band or a resin band with metal parts, use a soft toothbrush or similar tool to scrub the band with a weak solution of water and a mild neutral detergent, or with soapy water. Next, rinse with water to remove all remaining detergent and then wipe dry with a soft absorbent cloth. When washing the band, wrap the watch case with kitchen plastic wrap so it does not come into contact with the detergent or soap.
- For a resin band, wash with water and then wipe dry with a soft cloth. Note that sometimes a smudge like pattern may appear on the surface of a resin band. This will not have any effect on your skin or clothing. Wipe with a cloth to remove the smudge pattern.
- Clean water and sweat from a leather band by wiping with a soft cloth.
- Not operating a watch crown, buttons, or rotary bezel could lead to later problems with their operation. Periodically rotate the crown and rotary bezel, and press buttons to maintain proper operation.

## ● Dangers of Poor Watch Care

### Rust

- Though the metal steel used for your watch is highly rust-resistant, rust can form if your watch is not cleaned after it becomes dirty.
  - Dirt on your watch can make it impossible for oxygen to come into contact with the metal, which can lead to breakdown of the oxidization layer on the metal surface and the formation of rust.
- Rust can cause sharp areas on metal components and can cause band pins to fly out of position or to fall out. If you ever notice any abnormality immediately stop using your watch and take it to your original retailer or to an authorized CASIO service center.
- Even if the surface of the metal appears clean, sweat and rust in crevasses can soil the sleeves of clothing, cause skin irritation, and even interfere with watch performance.

### Premature Wear

- Leaving sweat or water on a resin band or bezel, or storing your watch in an area subject to high moisture can lead to premature wear, cuts, and breaks.

### Skin Irritation

- Individuals with sensitive skin or in poor physical condition may experience skin irritation when wearing a watch. Such individuals should keep their leather band or resin band particularly clean. Should you ever experience a rash or other skin irritation, immediately remove your watch and contact a skin care professional.

## Battery

- The special rechargeable battery used by your watch is not intended to be removed or replaced by you. Use of a rechargeable battery other than the special one specified for your watch can damage your watch.
- The rechargeable (secondary) battery can be charged by using the charging cable to connect the watch to a device equipped with a USB terminal, so it does not require regular replacement as the primary battery requires. Note, however, that long use or operating conditions can cause the capacity or charging efficiency of the rechargeable battery to deteriorate. If you feel that the amount of operation provided by charging is too short, contact your original retailer or CASIO service center.
- Regular, once-a-month charging is recommended to extend the service life of the watch's battery.

## Mobile Link Precautions

### ● Legal Precautions

- This watch complies with or has received approval under the radio laws of various countries and geographical areas. Using this watch in an area where it does not comply with or has not received approval under applicable radio laws may be a criminal offense. For details, visit the CASIO Website.

<https://world.casio.com/ce/BLE/>

- Use of this watch inside of aircraft is restricted under the aviation laws of each country. Be sure to follow the instructions of airline personnel.

### ● Precautions when using Mobile Link

- When using this watch in combination with a phone, keep the watch and phone close to each other. A range of two meters is recommended as a guideline, but the local environment (walls, furniture, etc.), the structure of a building, and other factors may require a much closer range.
- This watch can be affected by other devices (electrical devices, audio-visual equipment, office equipment, etc.) In particular, it can be affected by operation of a microwave oven. The watch may not be able to communicate normally with a phone if a microwave oven is operating nearby. Conversely, this watch may cause noise in radio reception and the video image of a TV.
- Bluetooth of this watch uses the same frequency band (2.4 GHz) as wireless LAN devices, and use of such devices in close proximity of this watch may result in radio interference, slower communication speeds and noise for the watch and the wireless LAN device, or even communication failure.

### ● Stopping Radio Wave Emission by This Watch

The  on the display indicates that the watch is emitting radio waves.

When in a hospital, on an aircraft, or in any other area where the use of radio waves is not allowed, enable the Airplane Mode.

 [Entering the Watch Airplane Mode](#)